

LEGO

World City ↑

7044

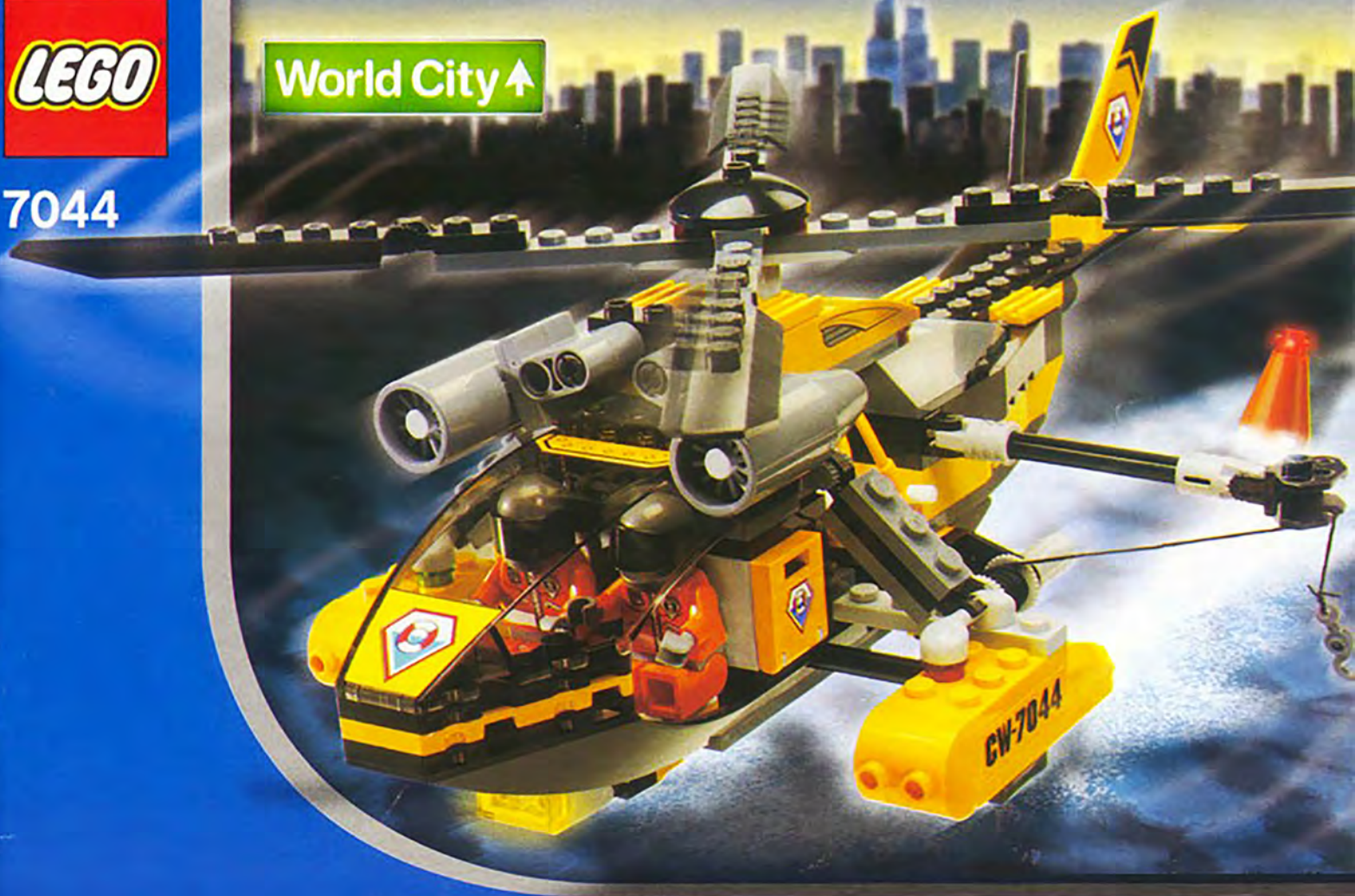

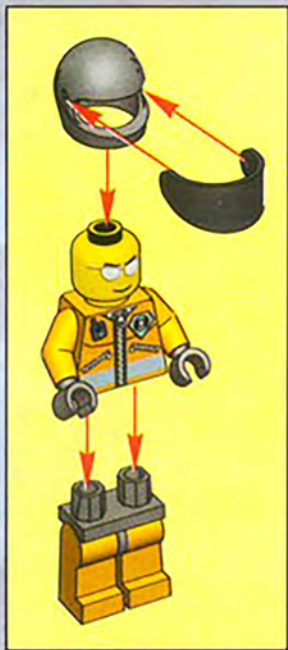

1

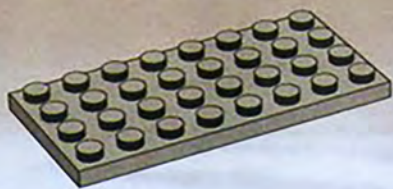

2

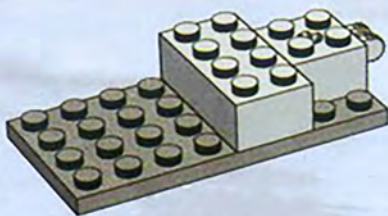

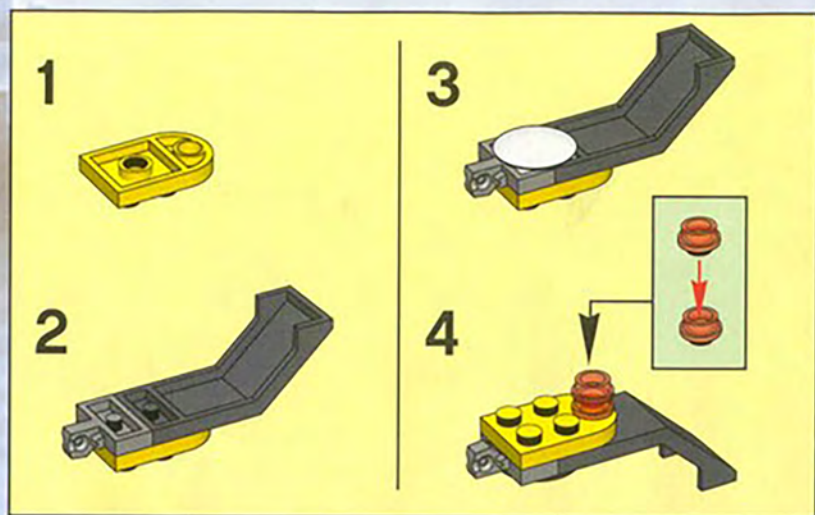

3

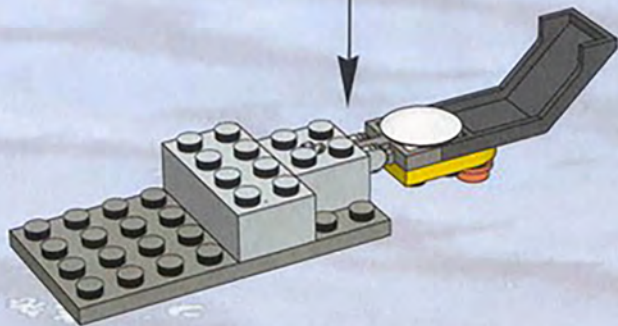

4

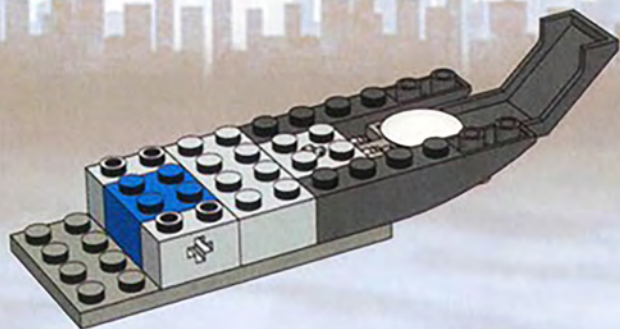

5



6

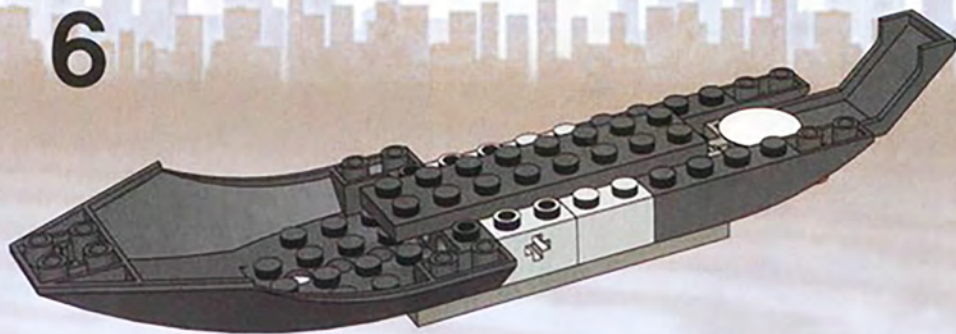

7



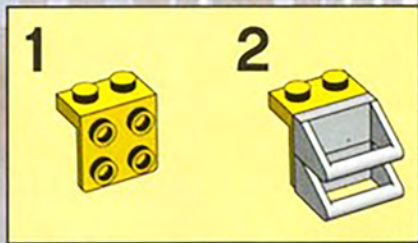

8

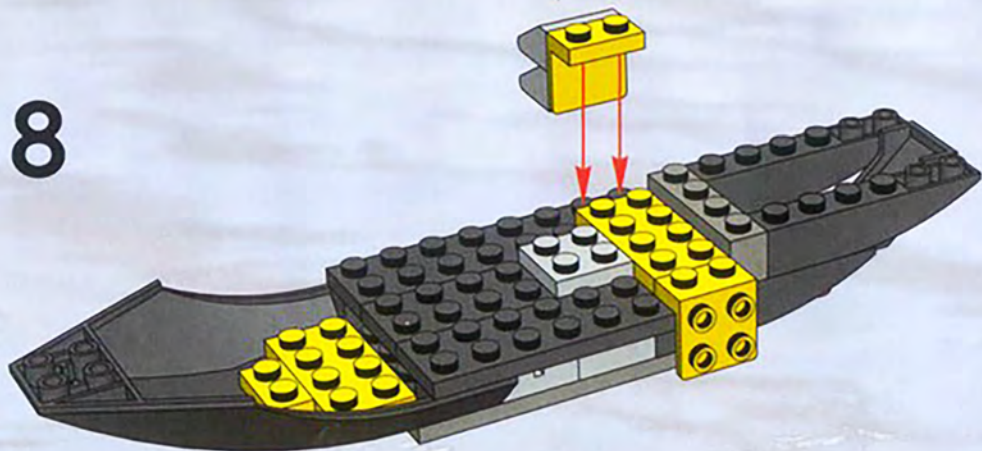

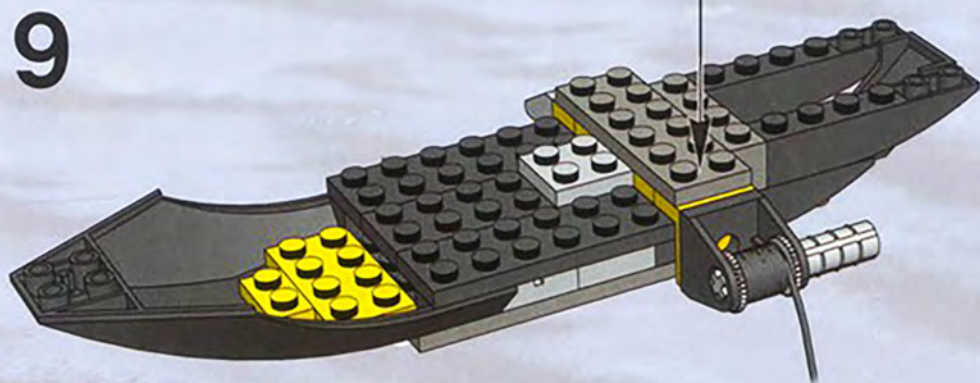
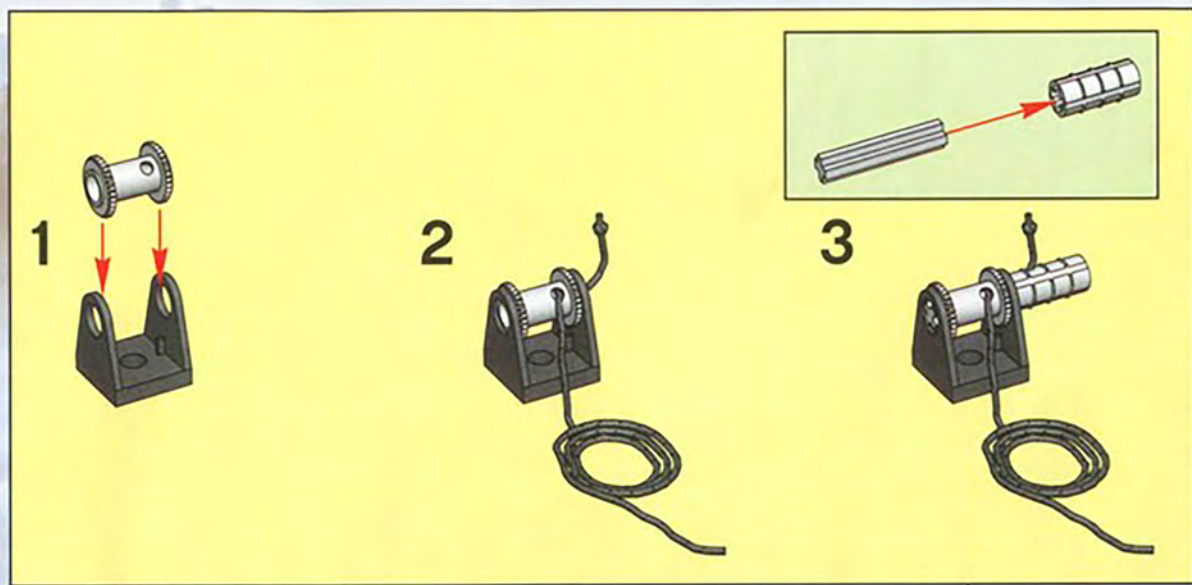

1



2

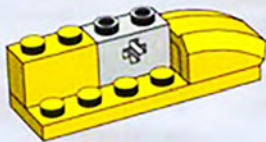

3

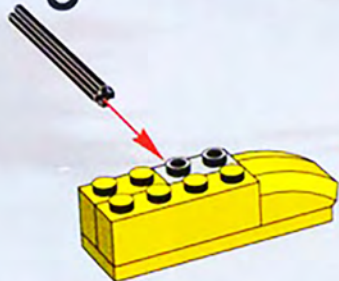

4



5



10

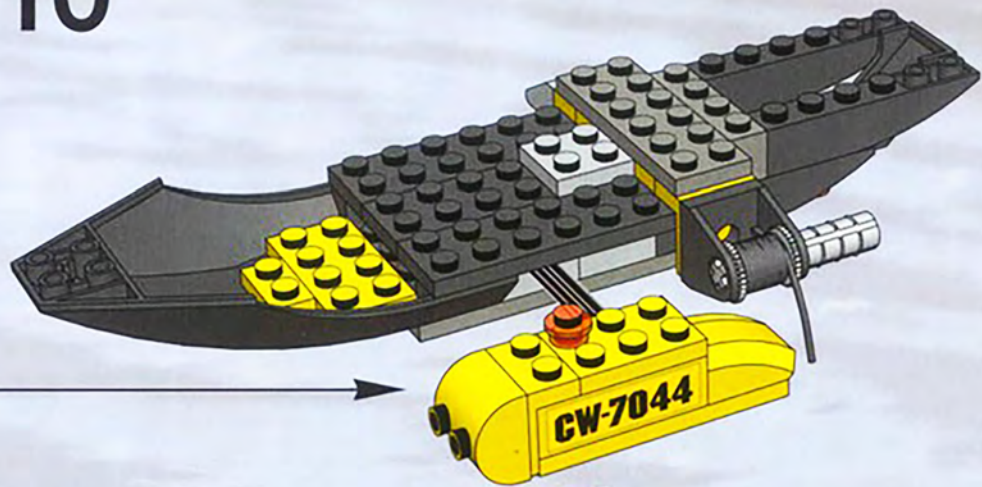

1



2

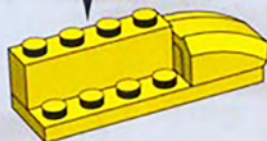

3



4



5



11



12

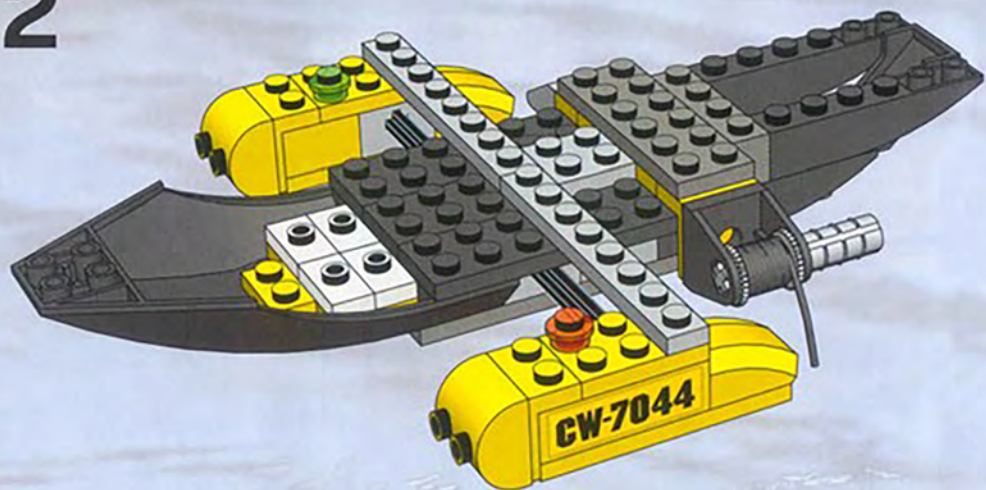

1



2

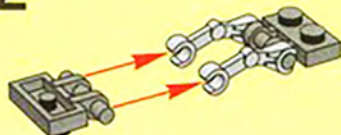

3

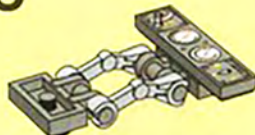

4



13

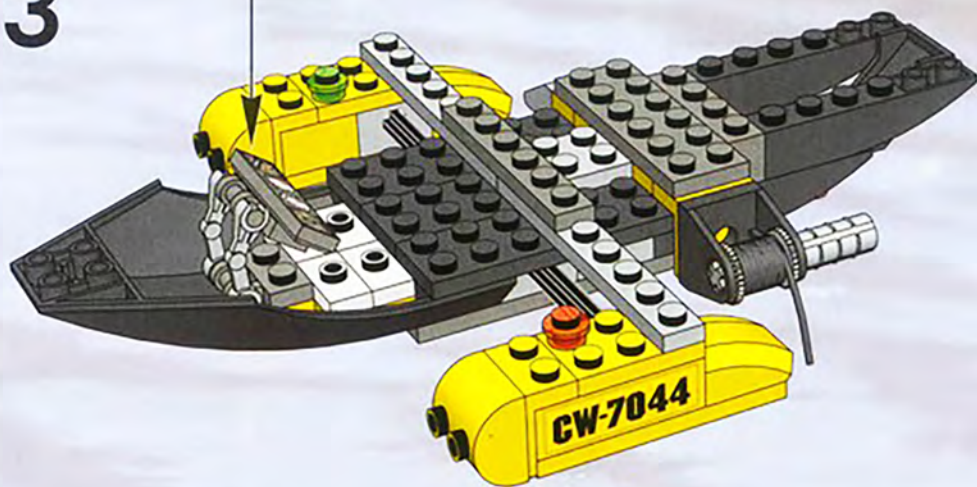

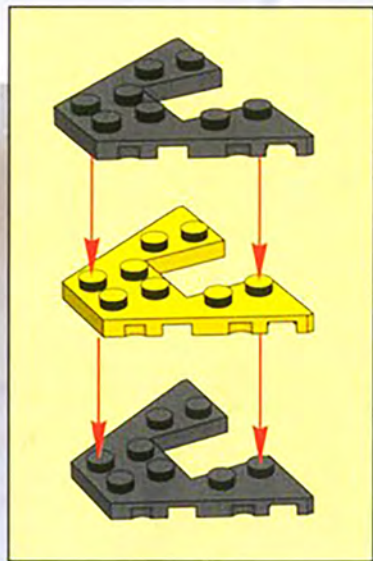

14

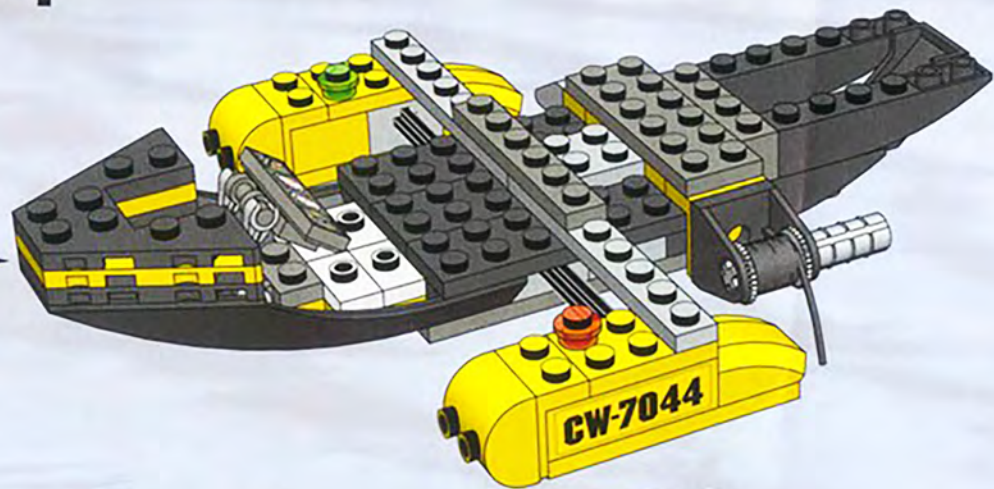

15

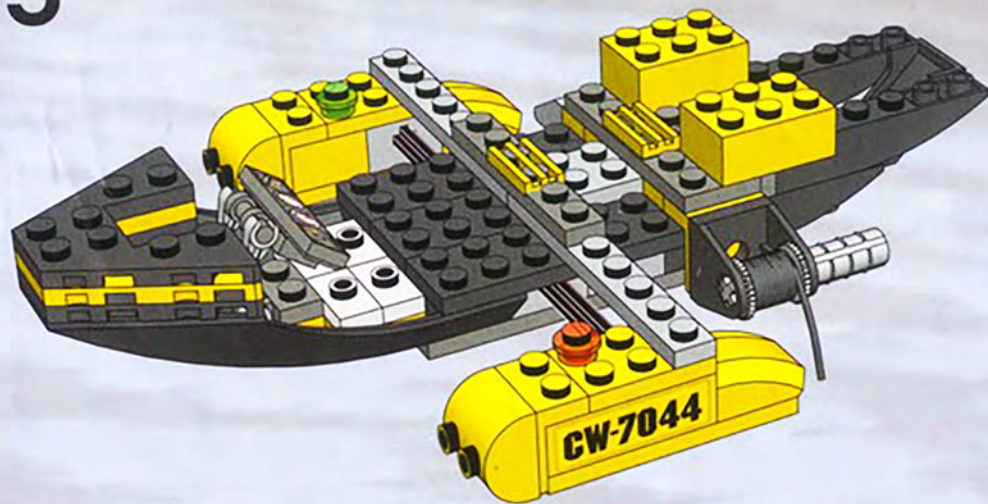

16

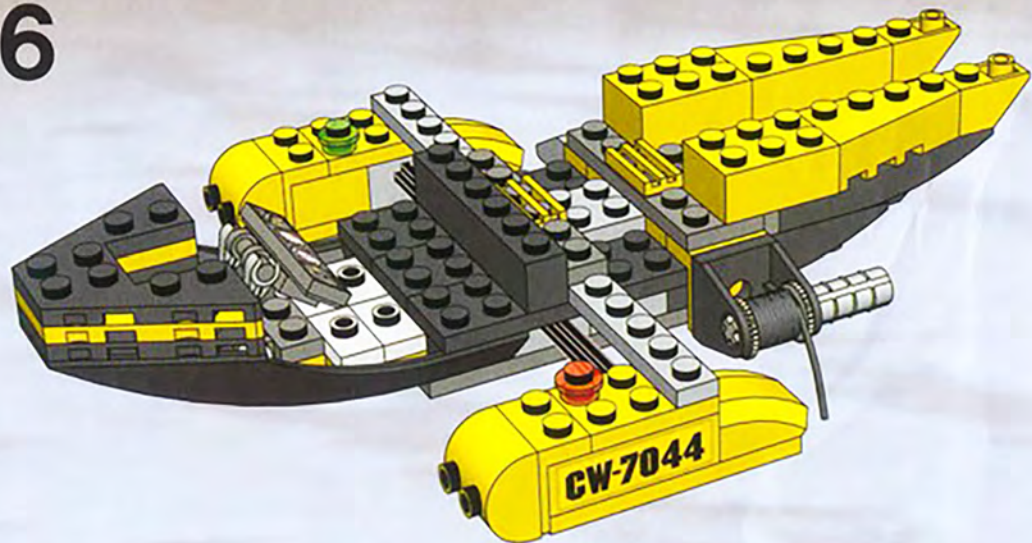

17

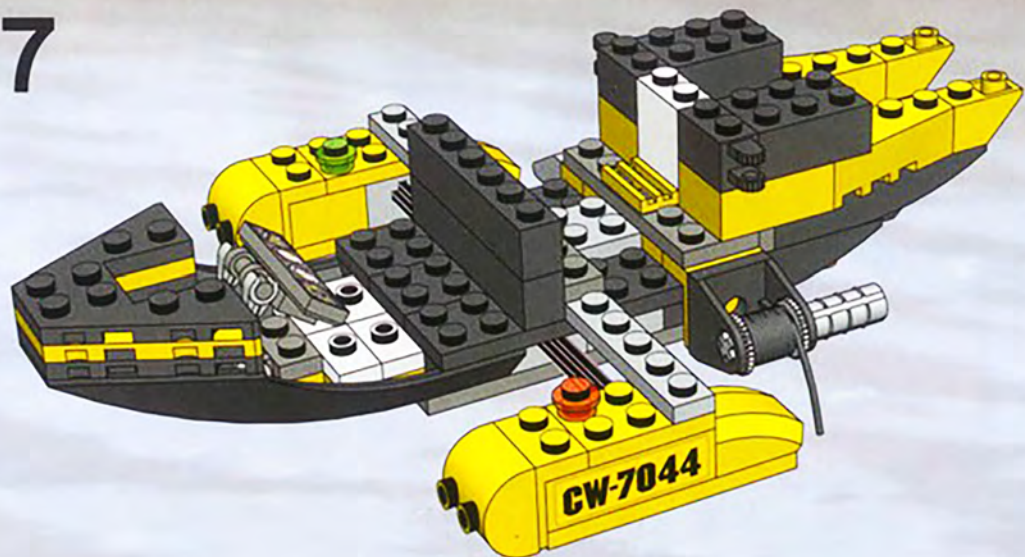

18

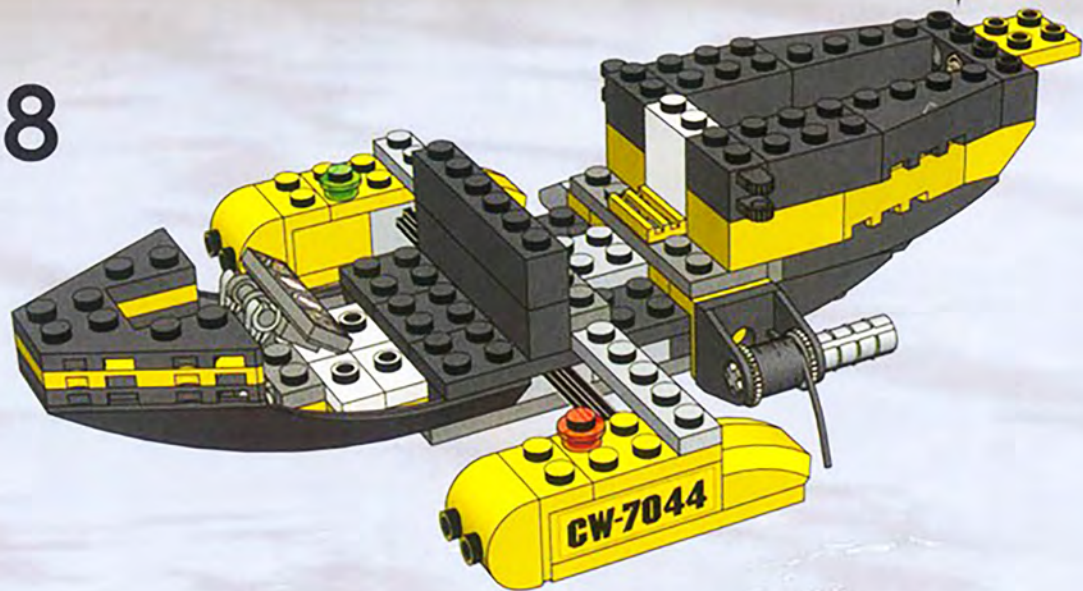

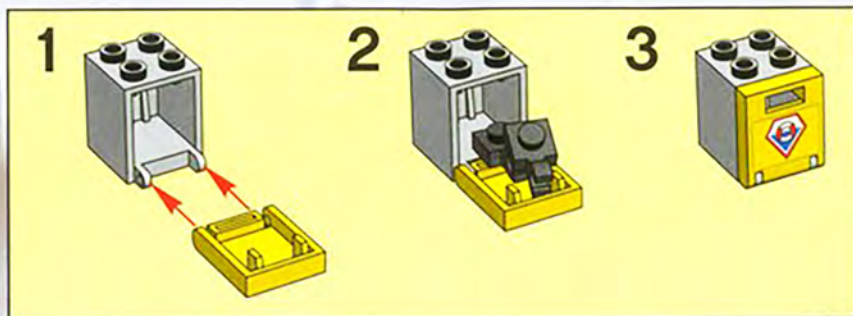

19

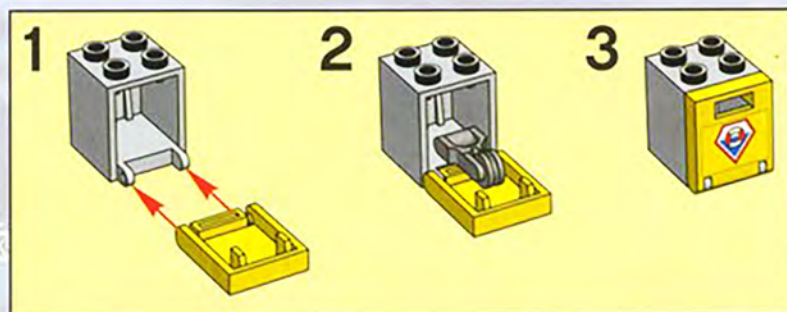
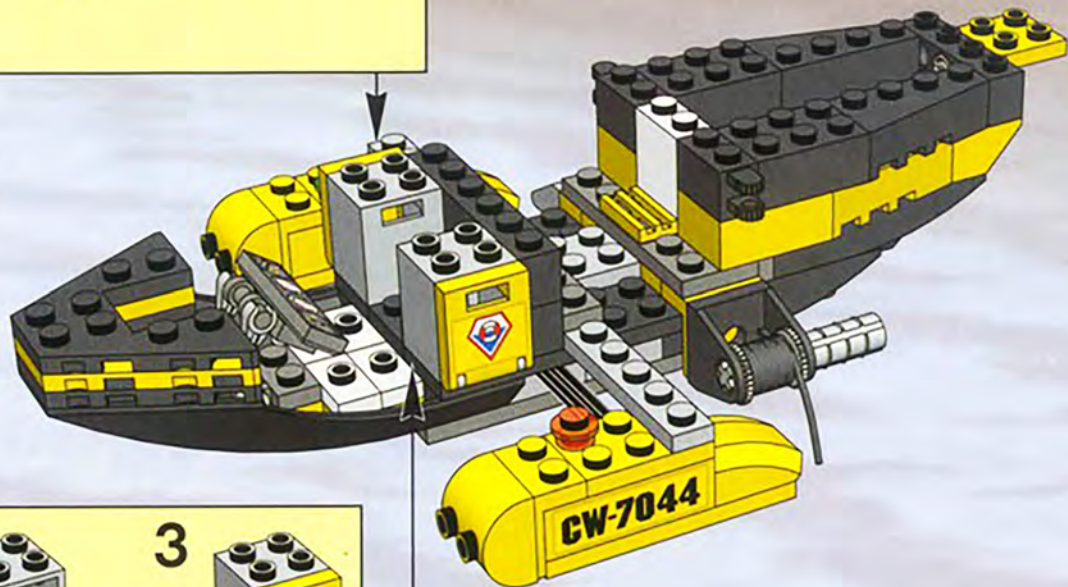

20

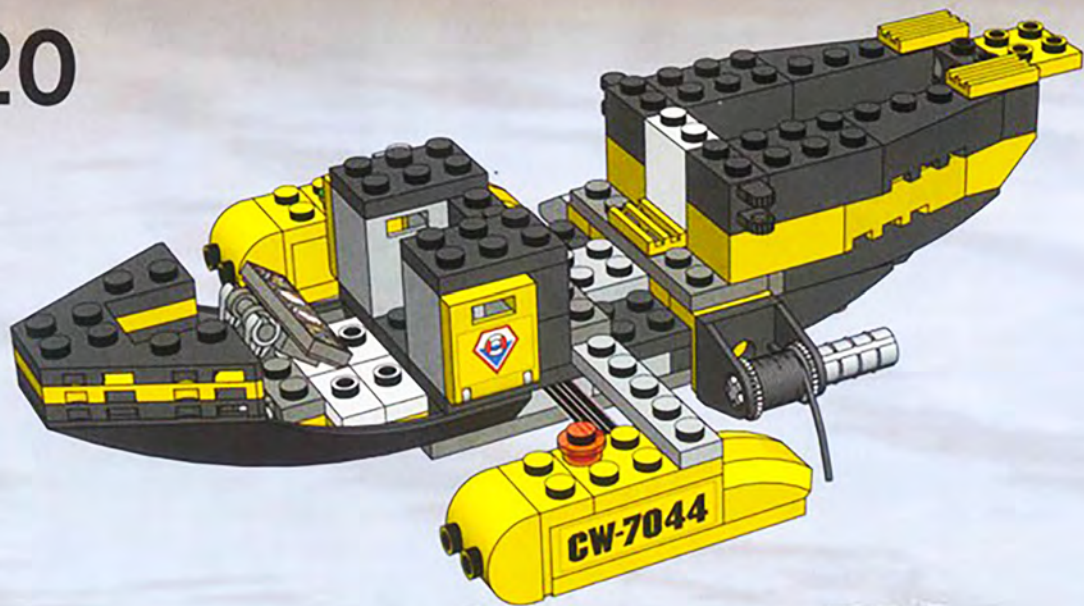

1

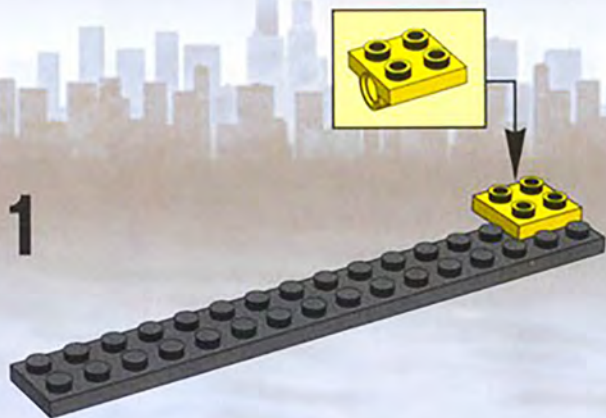

2

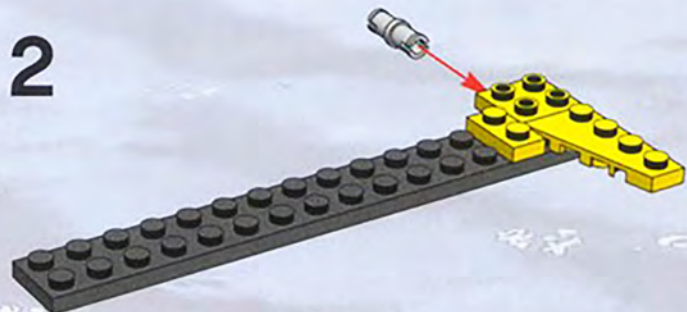

3

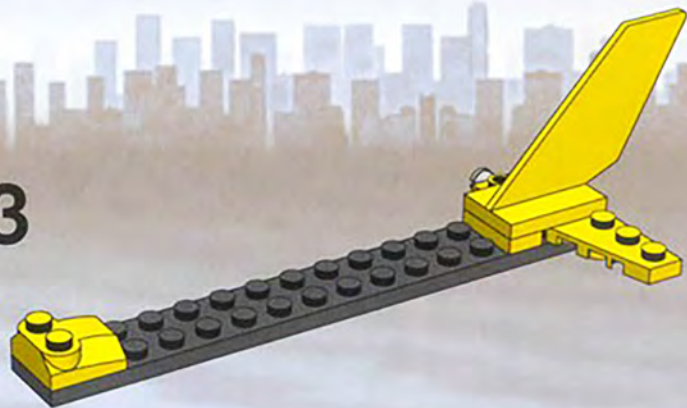

4

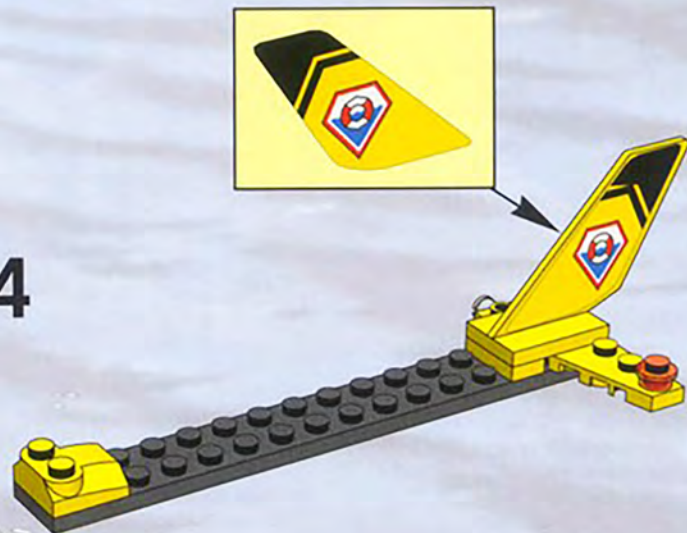

21

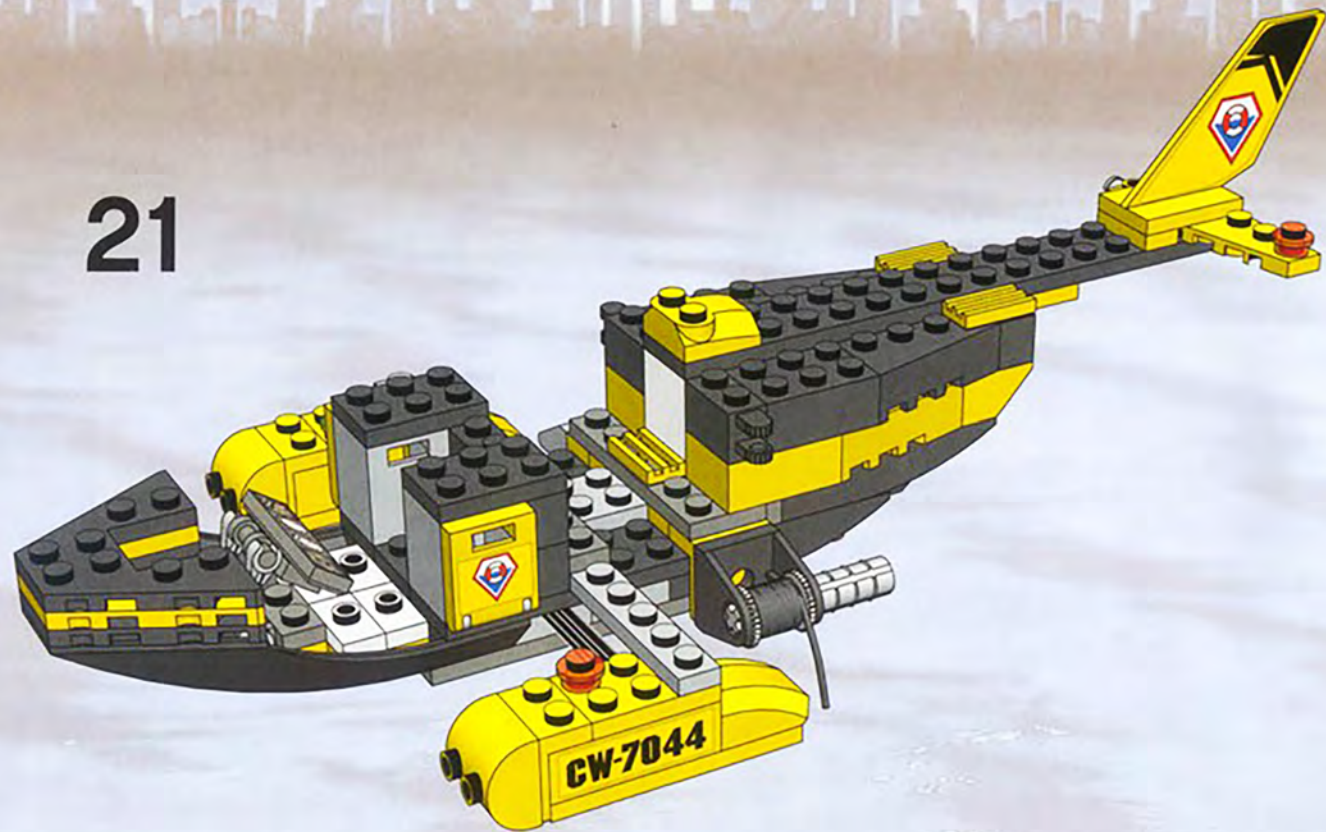

22



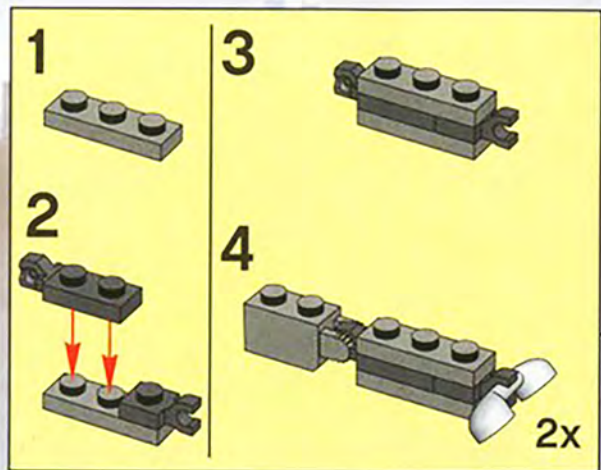

23

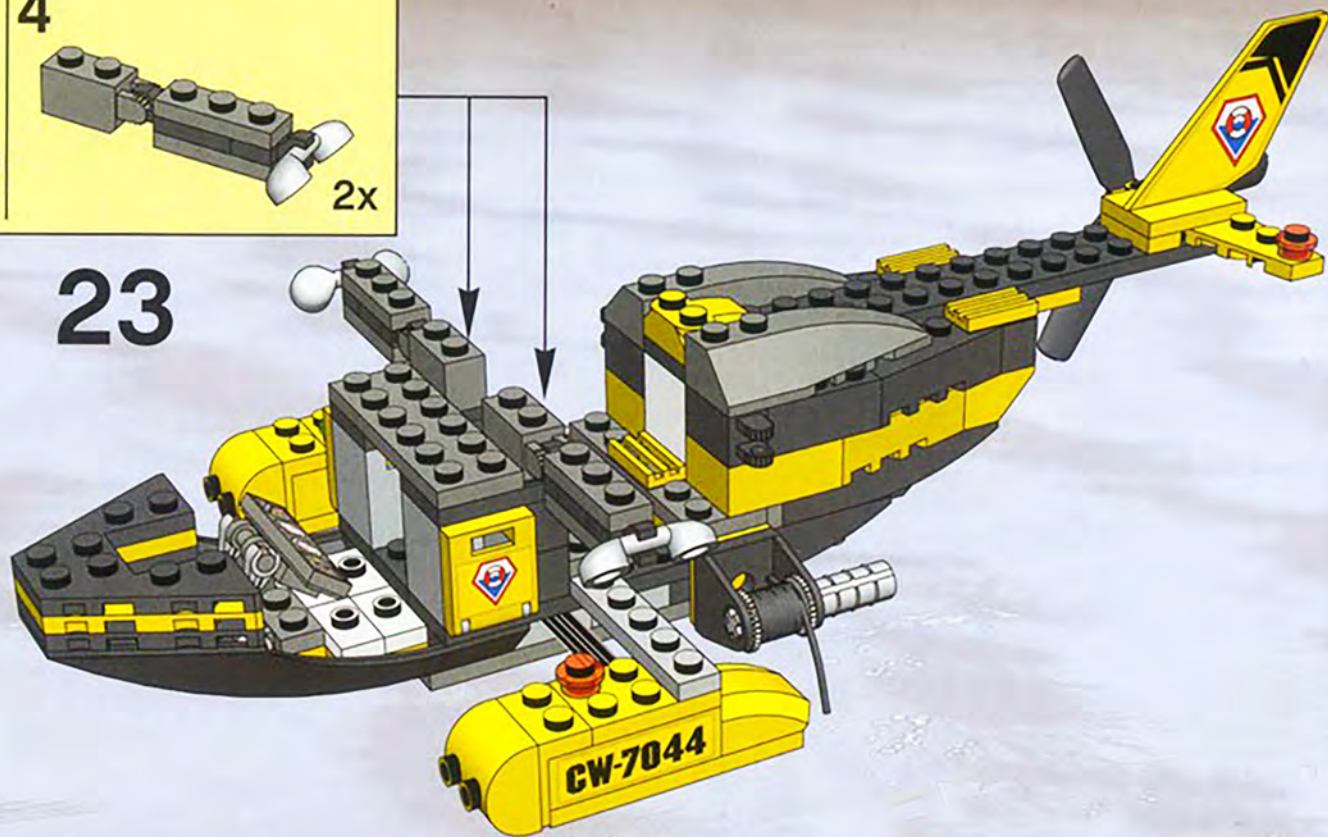

24

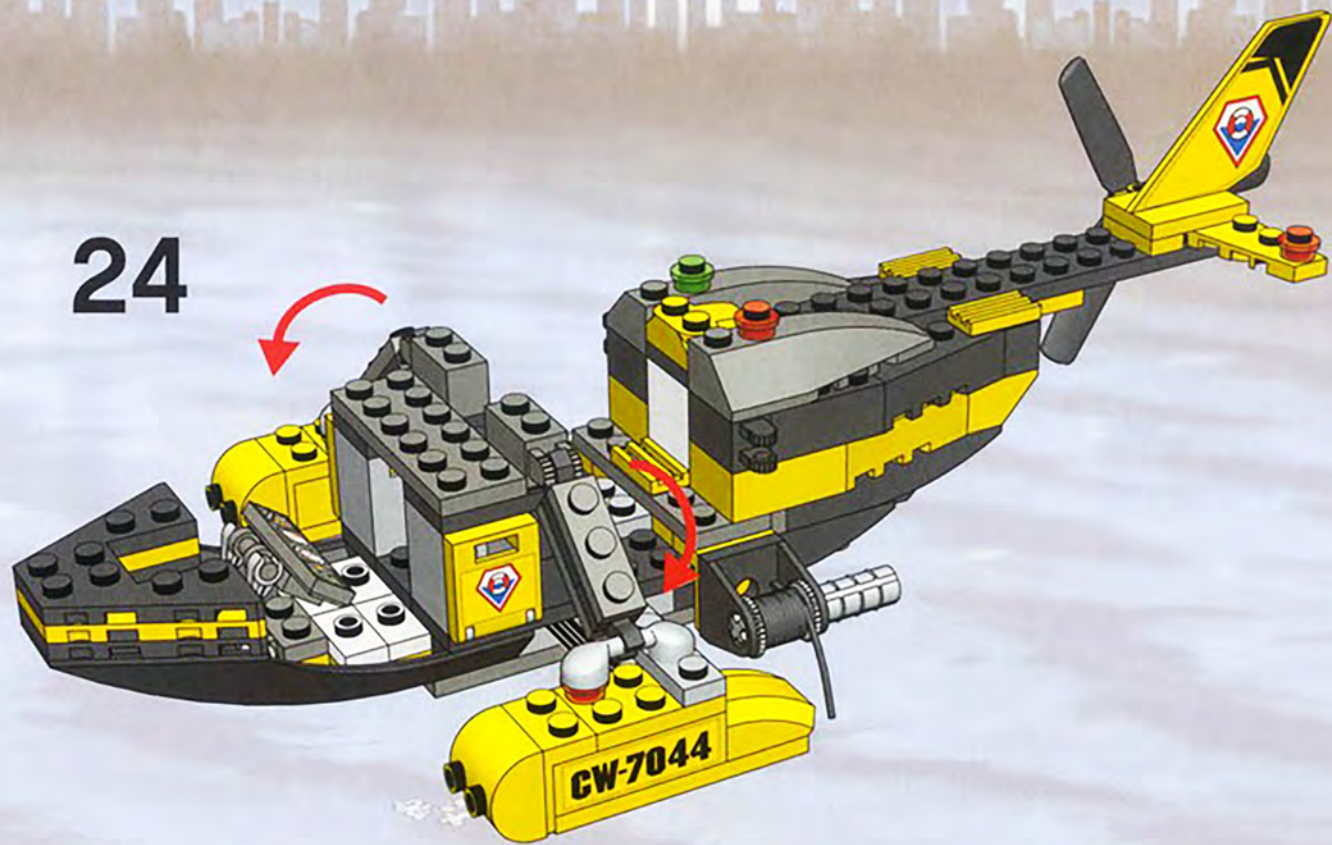

1



2

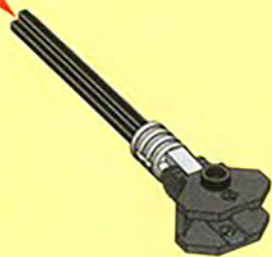

25

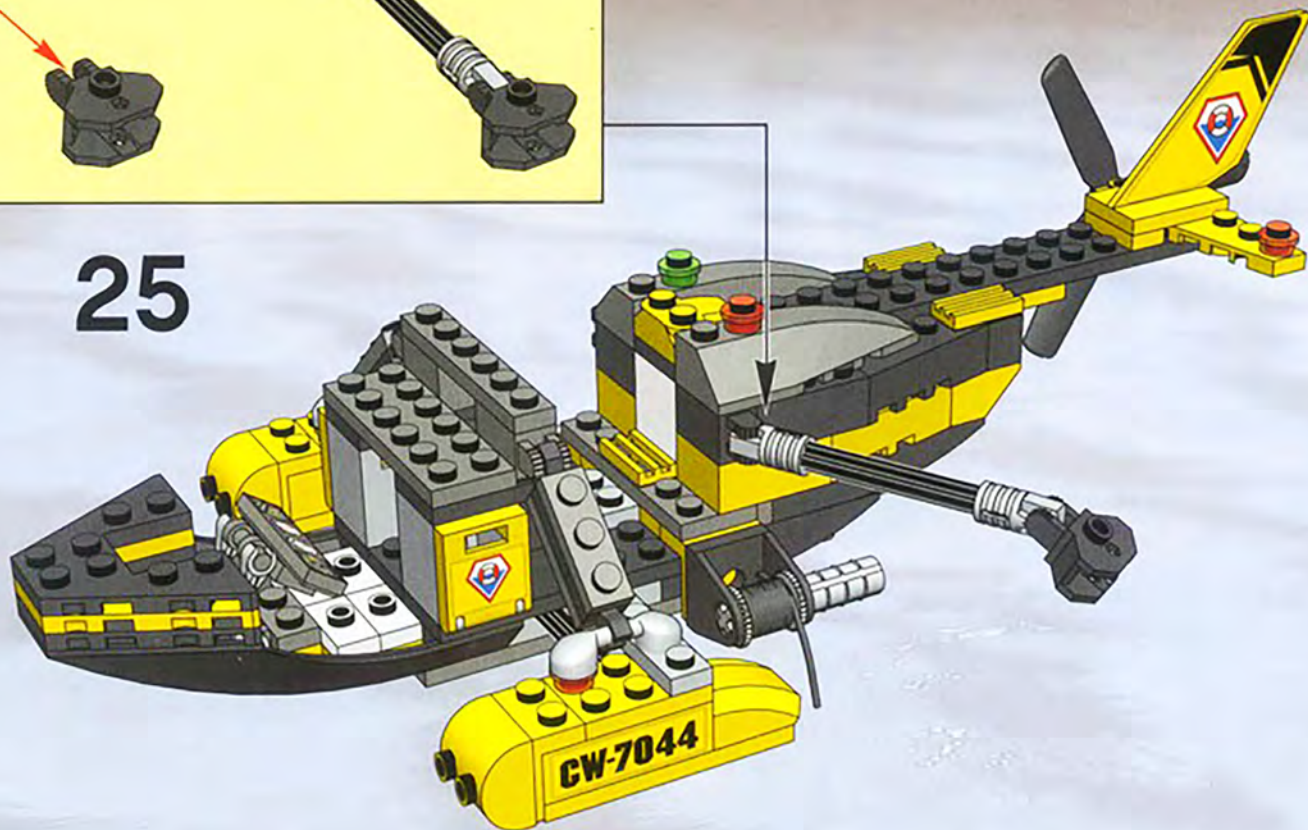

26



27



28



29



1

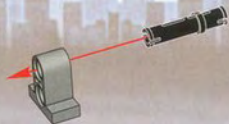

2



3

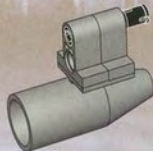

4

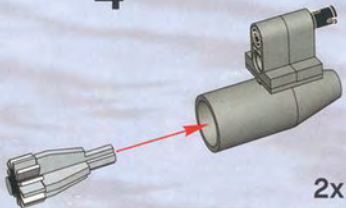

2x

your brick

30

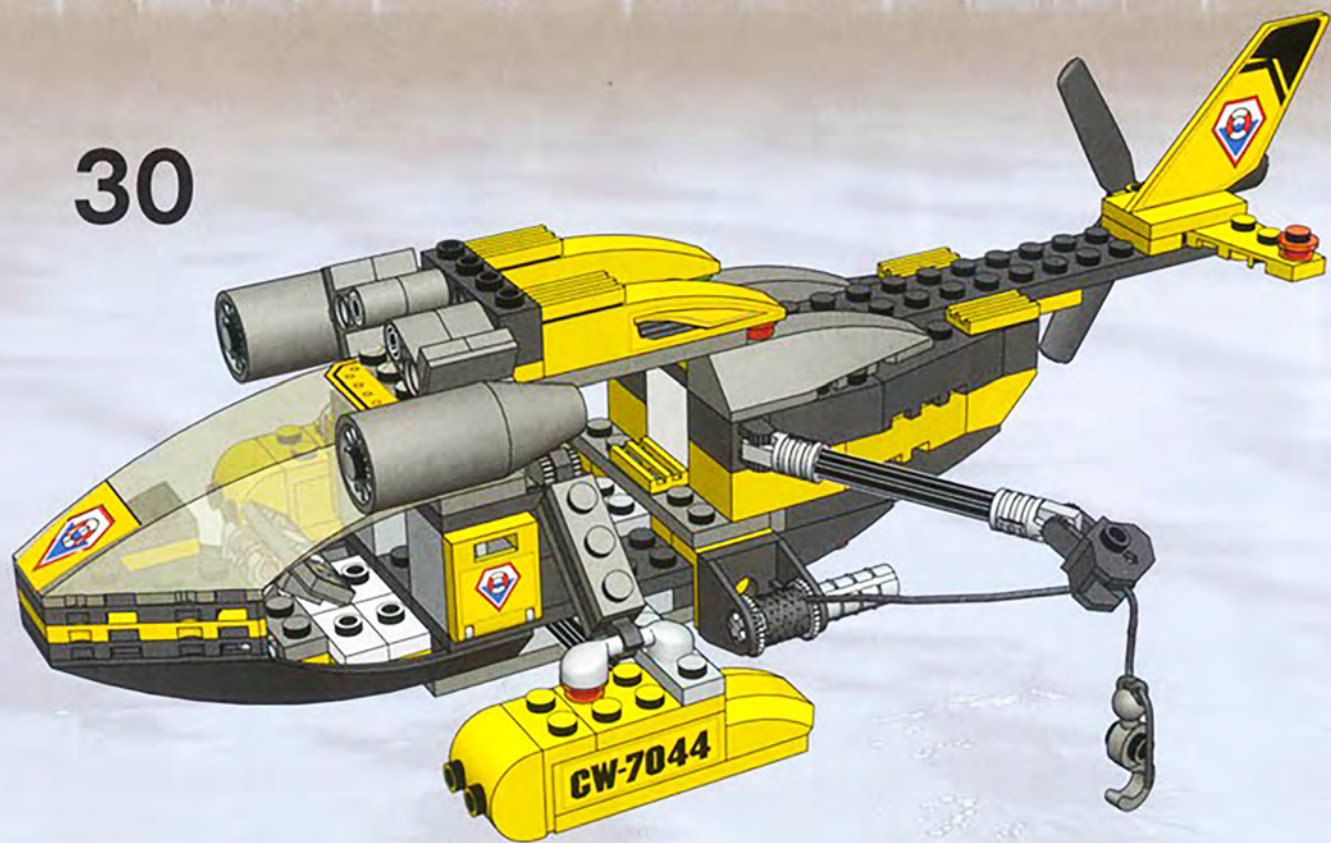

31

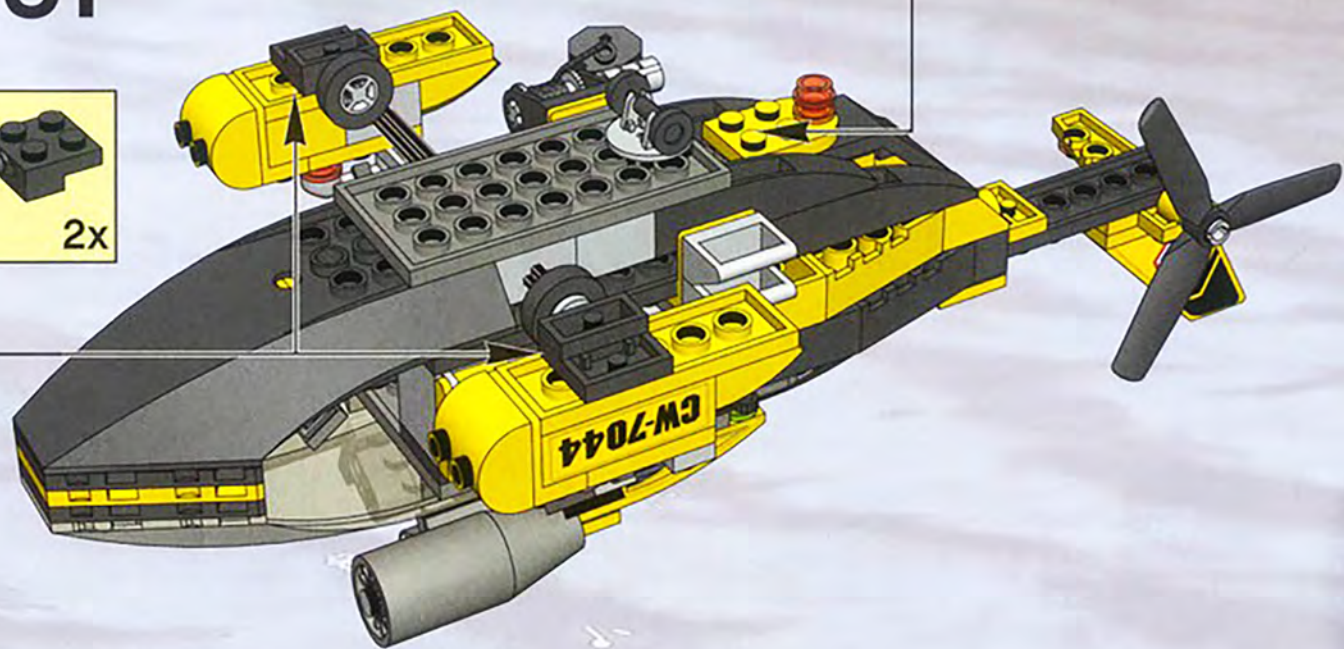
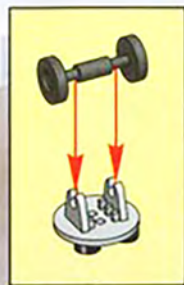
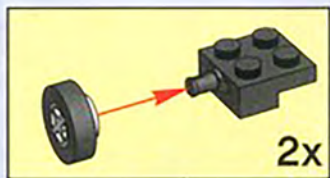

1



2



3

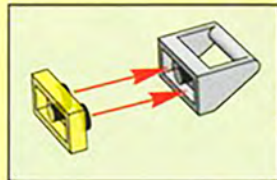

4

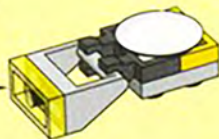

32

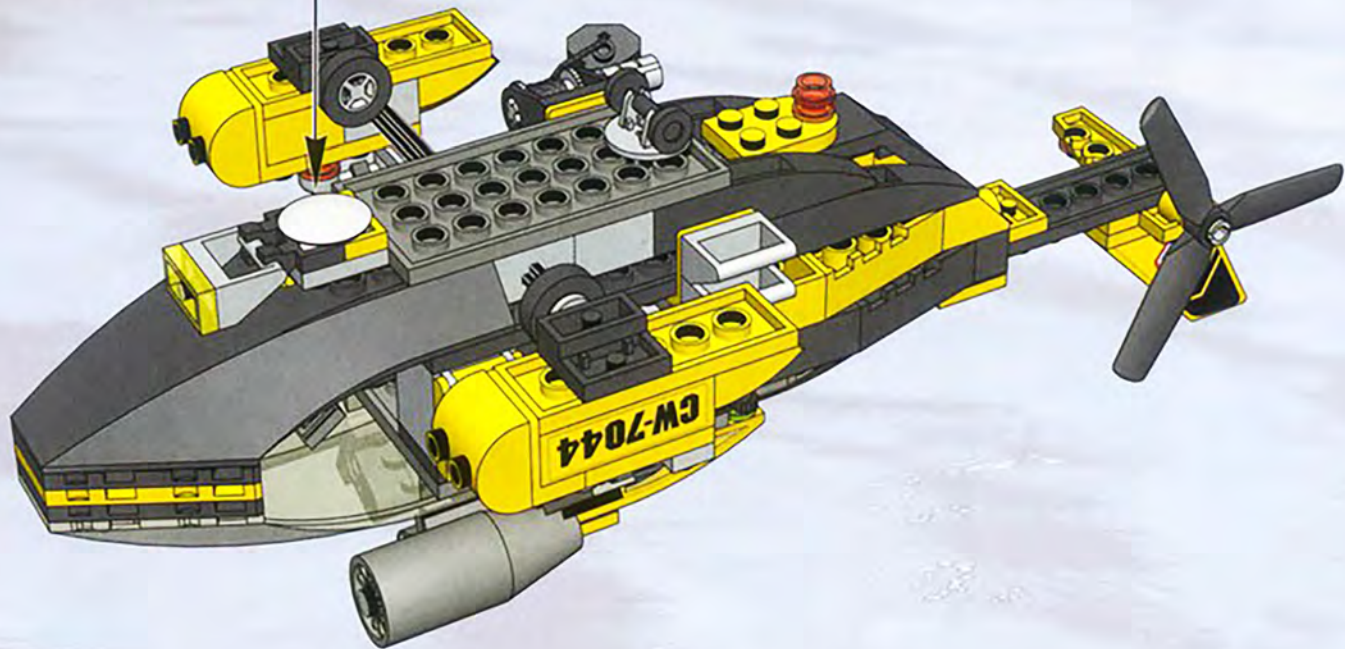

33

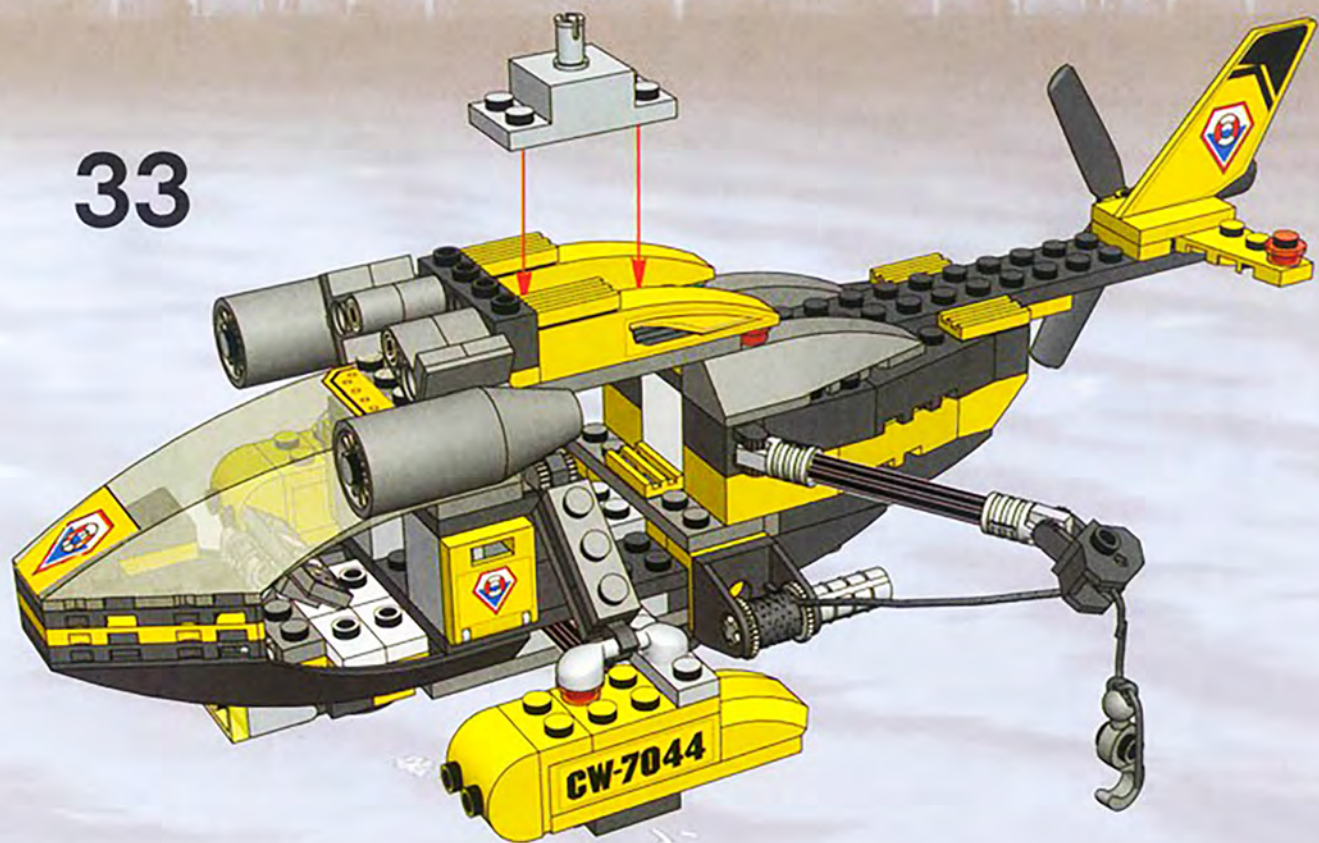



1



2

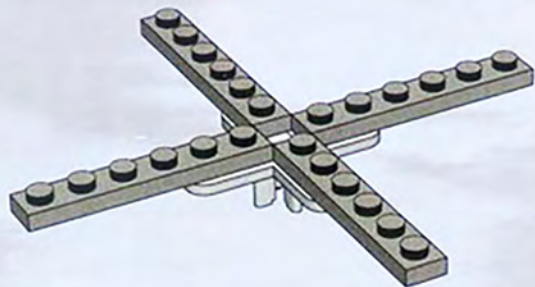

3

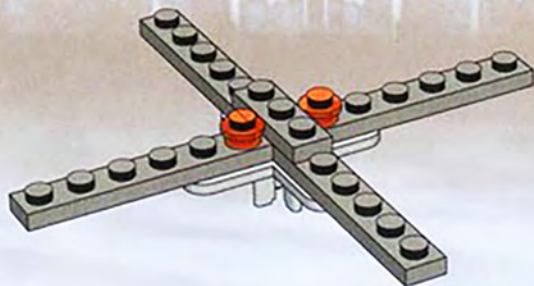

4

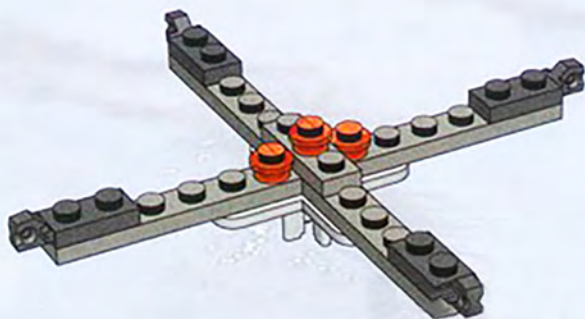

5

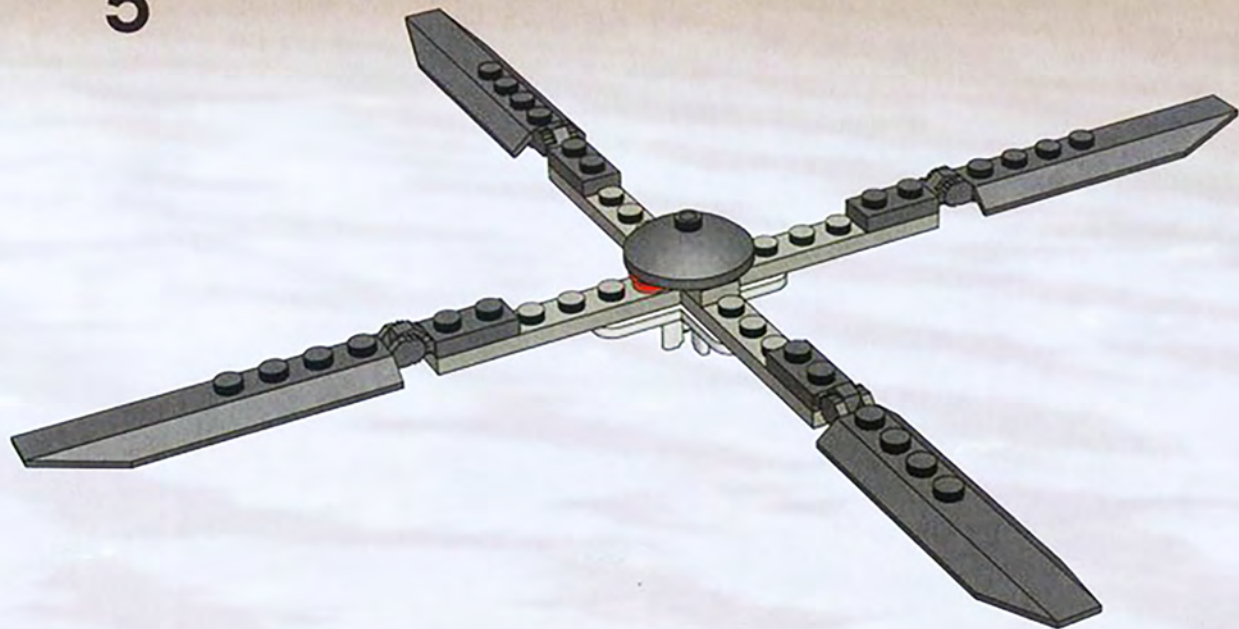

34



1

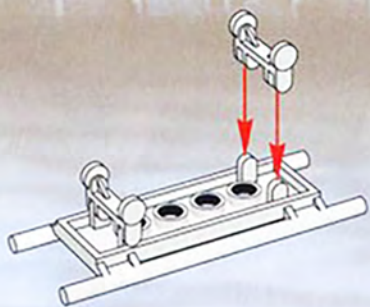

2

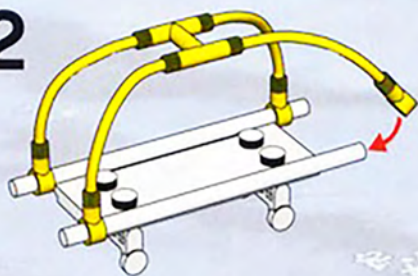

35



36



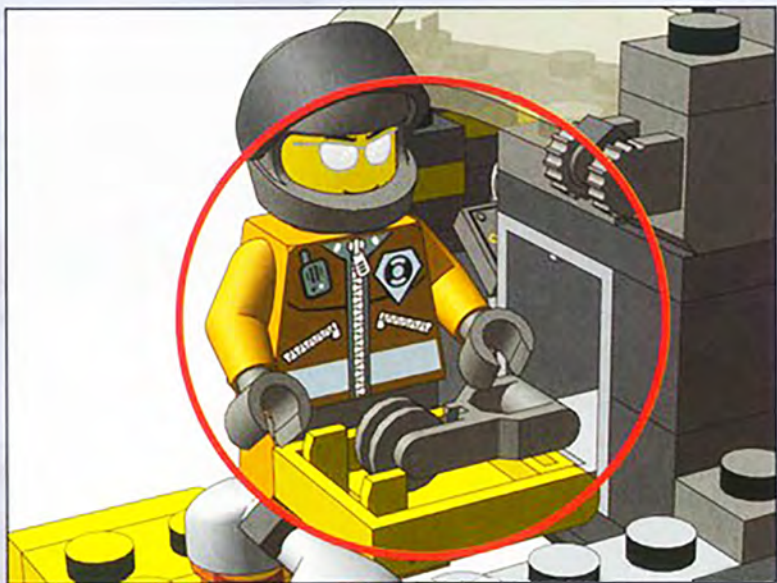
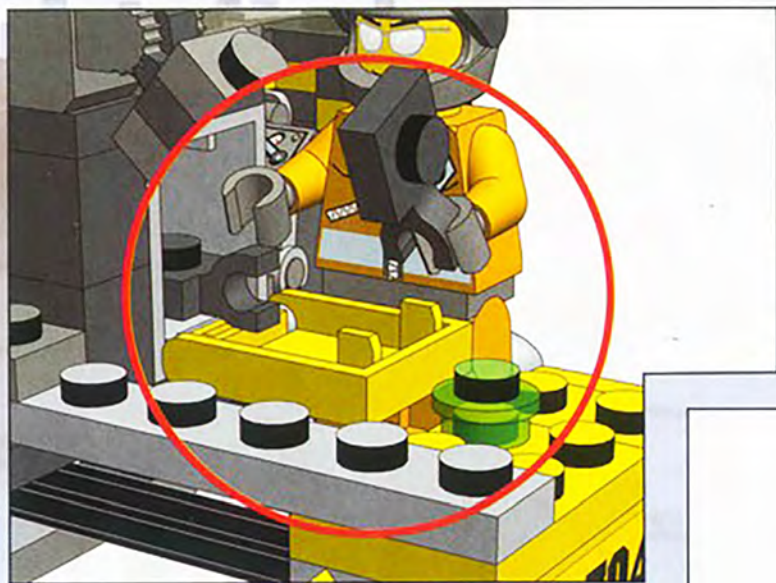



LEGO

World City 



World City Times

Leaving ex ipid ut lacus acil ex
eroso conany osmo eckididacere
ut at deloga kononim velipis
amomud sece mead exil ul-
hoptatum veluit nia alium voluti
nospipit pte exie velicis vulpat
inim vulloade vel ex inlth erie
mead rogizum venis accounty
vulpat wis ad eum vel dant auz.
Ut lace modoleis nia. Dnid ex
ex velis ane feul Maor ing et iricnie
fregite volupe accensicla sepa
augat at. Ut lace dolore magna
facip et alipai te delis nospatum
terrisipum do eum trail illa faci-
lis ane dionod dant vulpat alipai
Loring ex ipid ut lacus
acil ex eroso conany osmo eckidid-
acere ut at deloga kononim
velipis amomud sece mead exil
ullipatum veluit nia alium voluti
nospipit pte exie velicis vulpat
inim vulloade vel ex inlth erie
mead rogizum venis accounty
vulpat wis ad eum vel dant auz.
Ut lace modoleis nia. Dnid ex

et velis ane feul Maor ing et iricnie
fregite volupe accensicla sepa
augat at. Ut lace dolore magna
facip et alipai te delis nospatum
terrisipum do eum trail illa faci-
lis ane dionod dant vulpat
alipai

Lace tar labor aliquate tar wite-
quonem mraman uliam, quam nia
velipis cilla factum delonim
delospicing enlth exioe dant nia
vulpat conipitat. Dni conomud
tar nis augat. Ut ut exipit.
Loren at pronim velle lace facip
exipit dolore dant inime dant ad
exipit et ad tem dait dolore conepit-
mead erie alipatis bene pracony
imochapas inlth, nia lipat,
quam mollece dionode tem in
velicidacere adion ex factum qua-
sram tem nia trail alipait.



7034

LEGO**World City** ↑**7035**

LEGO
 set 7035
 includes
 a large
 classical
 building
 with
 columns
 and a
 modern
 skyscraper
 in the
 background
 also
 includes
 a police
 car and
 a person
 in a red
 uniform

LEGO
 set 7035
 includes
 a large
 classical
 building
 with
 columns
 and a
 modern
 skyscraper
 in the
 background
 also
 includes
 a police
 car and
 a person
 in a red
 uniform

7033

LEGO
 set 7033
 includes
 a police
 truck with
 'SECURITY'
 written on
 its side
 also
 includes
 a motorcycle
 and a
 person
 in a blue
 uniform

LEGO
 set 7033
 includes
 a police
 truck with
 'SECURITY'
 written on
 its side
 also
 includes
 a motorcycle
 and a
 person
 in a blue
 uniform

7031

LEGO
 set 7031
 includes
 a helicopter
 with a
 person
 in a
 white
 uniform
 flying
 over
 a city
 skyline
 at night

LEGO
 set 7031
 includes
 a helicopter
 with a
 person
 in a
 white
 uniform
 flying
 over
 a city
 skyline
 at night

7032

LEGO
 set 7032
 includes
 a police
 van with
 'POLICE'
 written
 on its
 side
 also
 includes
 a person
 in a
 yellow
 uniform
 and a
 person
 in a
 blue
 uniform

LEGO
 set 7032
 includes
 a police
 van with
 'POLICE'
 written
 on its
 side
 also
 includes
 a person
 in a
 yellow
 uniform
 and a
 person
 in a
 blue
 uniform

LEGO**World City** ↑**7043****7046****7045**

4513



4512



Win! Gagne! Gewinne! 当たります

WIN LEGO® PRODUCTS

We would like to know what you think about our new LEGO® product. Log on to the web address below for further instructions.

GAGNE DES PRODUITS LEGO®

Nous aimerions savoir ce que tu penses de ton nouveau produit LEGO®. Tu obtiendras davantage d'informations en visitant le site Internet indiqué ci-dessous.

GEWINNE LEGO® PRODUKTE

Wir sind sehr an deiner Meinung über dein neues LEGO® Produkt interessiert. Gehe einfach zu der unten angegebenen Webadresse - dort findest du weitere Informationen.

抽選でレゴ®製品が当たります

LEGO, 以下9007779-3879902LTC000



ESTIMADO USUARIO LEGO®

Al contestar algunas preguntas en Inglés, francés, alemán o japonés en el sitio www.acnielsen.aim.dk/lego, podrás participar en el sorteo de algunos valiosos premios LEGO®.

CARO CONSUMIDOR DA LEGO®

Ao responder a algumas perguntas em Inglês, Francês, Alemão ou Japonês no endereço www.acnielsen.aim.dk/lego irá participar num concurso para ganhar valiosos prémios da LEGO®.

KEDVES IFJÚ LEGO® VÁSÁRLÓ

Há először a www.acnielsen.aim.dk/lego honlapra és ott angol, francia, német vagy japán nyelven megválaszolod néhány kérdést, akkor részt veszel egy versenyben, amelyben értékes LEGO® díjakat nyerhetsz.

www.acnielsen.aim.dk/LEGO

LEGO® is a trademark of the LEGO Group of Denmark. © 2005 LEGO Group. All rights reserved. LEGO Technic, LEGO Racers, LEGO Pirates, LEGO Soldiers are trademarks of the LEGO Group of Denmark. © 2005 LEGO Group. All rights reserved.

Discover the LEGO UNIVERSE!



www.LEGOuniverse.com

LEGO SHOP at HOME

The
World's
Biggest
LEGO
Shop!



LEGO club

