

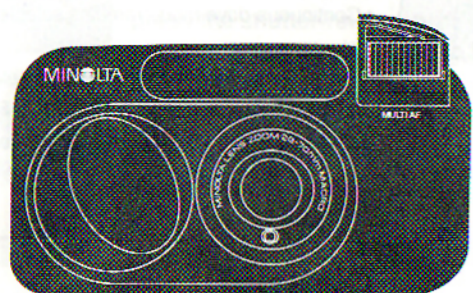

**RIVA ZOOM 70W
FREEDOM ZOOM EXPLORER
FREEDOM ZOOM EXPLORER PANORAMA DATE**
E INSTRUCTION MANUAL



Minolta Co., Ltd.
3-13, 2-Chome, Azuchi-Machi, Chuo-Ku, Osaka 541, Japan
Kurfischer-Strasse 50, D-22923 Ahrensburg, Germany
365, Route de Saint-Germain, F-78420 Carnières-Sur-Seine, France
Rooksley Park, Procdornt Drive, Rooksley, Milton Keynes, MK13 8HF, England
Amalienstrasse 59-61, A-131 Wien, Austria
Zonnebaan 39, P.O. Box 6000, NL-3600 HA Maarssen, The Netherlands
Kontschestserweg 38, B-2630 Aartselaar, Belgium
Riedstrasse 6, CH-8963 Diefikon, Switzerland
P.O. Box 9058, Albygotan 114, S-17109 Soina, Sweden
Nittiykatu 6 Pt. 37, SF-02201 Espoo, Finland
Av. do Brasil 33-A, P-1700 Lisboa, Portugal
101 Williams Drive, Ramsey, New Jersey 07446, U.S.A.
11150 Hope Street, Cypress, CA 90630, U.S.A.
369 Britannia Road East, Mississauga, Ontario L4T 2H5, Canada
230-3771 Jaccobs Road, Richmond, B.C. V6V 2L9, Canada
Room 208, 2/F, Eastern Center, 1065 King's Road, Quarry Bay, Hong Kong, China
10, Teban Gardens Crescent, Singapore 608923
368 Minolta Road, Songjiang, Shanghai, China
© 1995 Minolta Co., Ltd. under the Berne Convention and Universal Copyright Convention 9222-2428-11 P-801 Printed in Japan

NAMES OF PARTS

- Shutter-release button
- Date buttons (DATE model only)
- Data panel
- Subject-program selector
- Self-timer/Drive-mode button
- Flash-mode button
- Flash*
- Back-cover release
- Viewfinder window*
- Metering window*
- Lens*

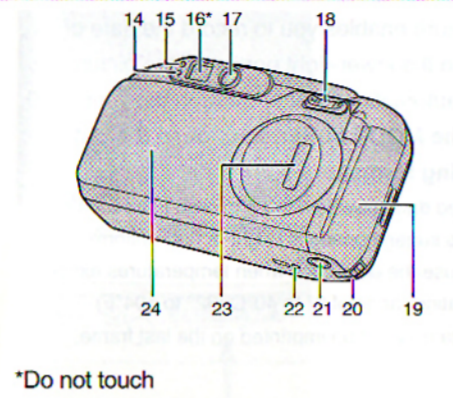
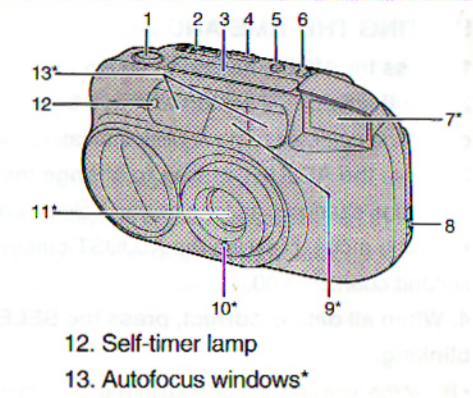

- Flash lamp (orange)
- Focus lamp (green)
- Viewfinder*
- On/Off button
- Zoom control
- Battery cover
- Strap eyelet
- Tripod socket
- Rewind button
- Film window
- Back cover

DATA PANEL

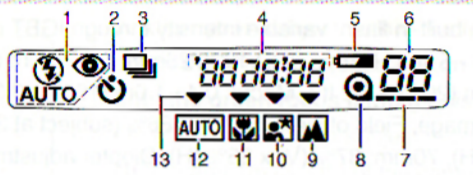

- Flash-mode indicator
- Self-timer indicator
- Continuous-drive indicator
- Date/Time display (DATE model only)
- Low-battery symbol
- Frame counter
- Film-transport signals
- Film-cartridge mark
- Landscape-mode indicator
- Night-portrait-mode indicator
- Macro-mode indicator
- Full-auto-mode indicator
- Subject-program pointer

VIEWFINDER

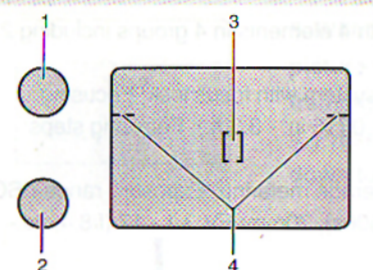

- Focus lamp (green)
Glow: Focus confirmed
Blinks: Subject too close
- Flash lamp (orange)
Glow: Flash will fire
Blinks quickly: Flash charging
Blinks slowly: Camera-shake warning
- Focus frame
- Close-framing guides

Thank you for purchasing a Minolta camera and welcome to the wonderful world of photography. This camera is equipped with functions which will suit your every photographic need. Before using your new camera, please take the time to read through this instruction manual for it contains important information on the use and care of your camera.

1. ATTACHING THE STRAP

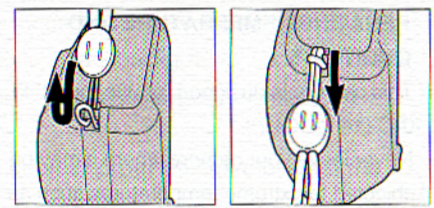

Attach the strap as shown.

2. INSERTING THE BATTERY

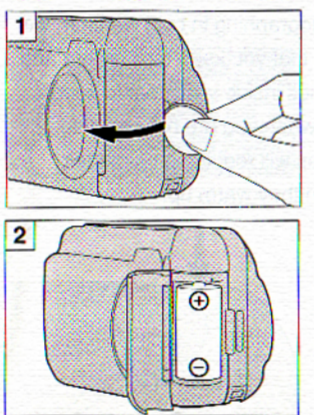

Your camera uses one 3-volt CR123A or DL123A lithium battery that supplies power for all camera operations.

- Open the battery cover using a coin or similar object.
- Insert the battery according to the + and - marks inside the battery chamber and snap the cover closed.

- Before removing an old battery, make sure the camera is off.

LOW-BATTERY SYMBOL

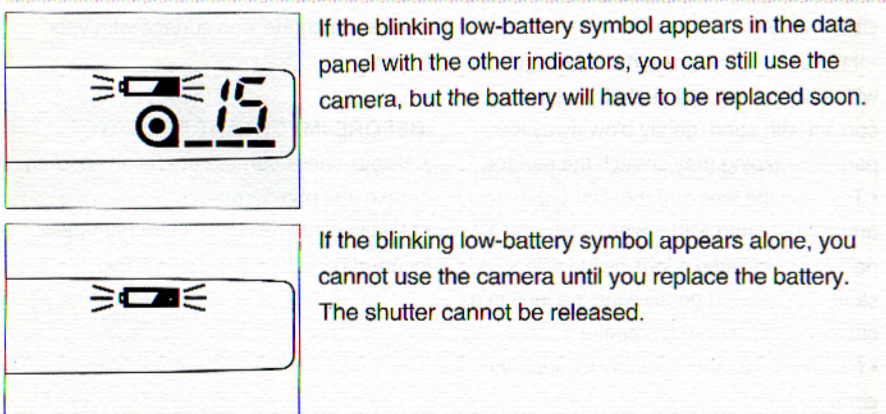

3. LOADING THE FILM

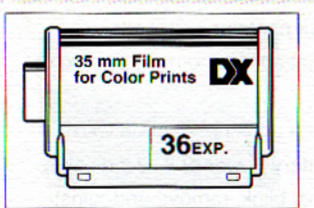

Use only 35mm, DX-coded film rated ISO 25 to 3200. We recommend ISO 400 or higher for taking telephoto photographs or pictures in low light.

- Always check the film window to make sure there is no film in the camera before opening the back cover.
- Always load and unload the film in subdued light.
- Do not use Polaroid instant 35mm film. Winding problems may occur.

LOADING THE FILM CONT.

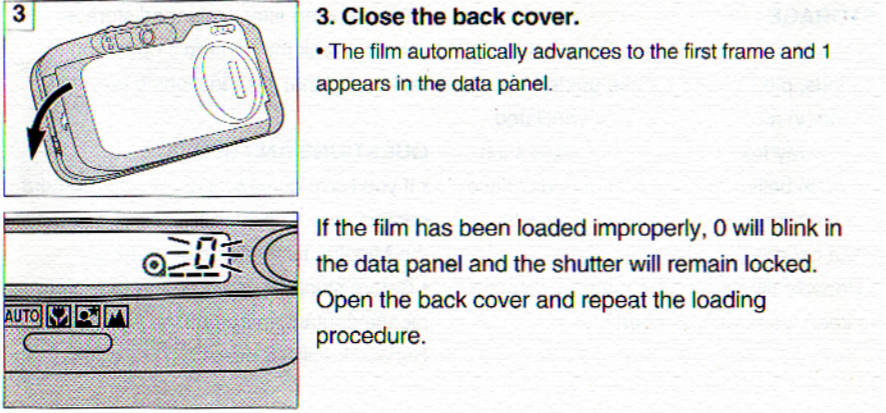
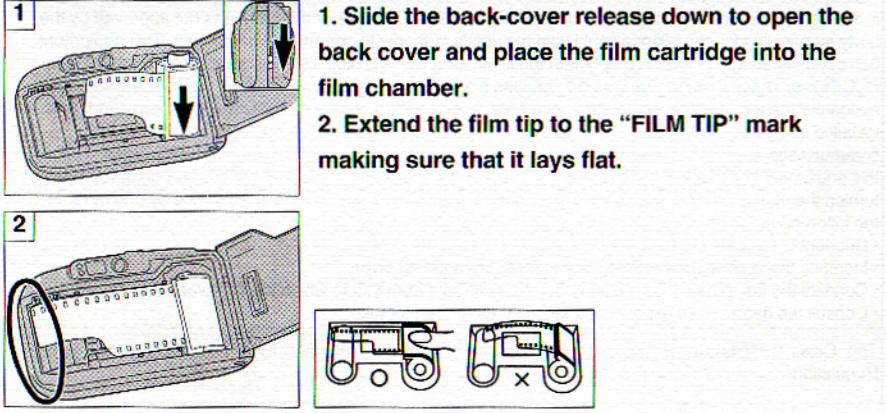

4. FULL-AUTO OPERATION

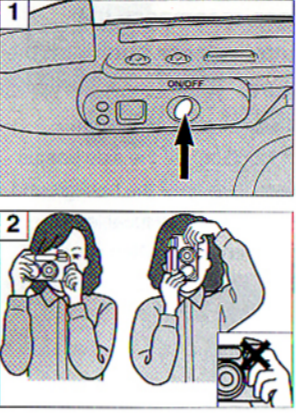

- Press the ON/OFF button to turn the camera on.
 - Hold the camera steady.
- To conserve power, the camera automatically turns off if it is not operated for more than three minutes.
 - Make sure your fingers and the strap are not blocking the flash, metering windows or other camera features.
 - Do not hold the flash down; the shutter may not release.
 - For vertically framed pictures, hold the camera so the flash is on top.
 - Do not hold the lens barrel; focus may not be accurate.



- Look through the viewfinder and press the W side of the zoom control to move towards wideangle or the T side to move towards telephoto.
- Align your subject within the focus frame and press the shutter-release button partway down.

FULL-AUTO OPERATION CONT.

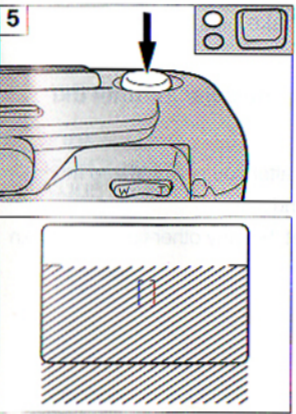

- When the green focus lamp glows, gently press the shutter-release button all the way down to take the picture.
- The flash will automatically fire in low light.
 - The film automatically advances to the next frame.

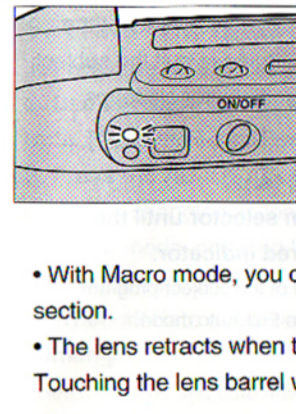

- If the green focus lamp blinks, your subject is closer than the minimum focusing distance of 0.5m (20 in.) and will not be in focus. The shutter cannot be released.
- If the subject is very close to the camera, the green focus lamp will glow, but the picture will not be in focus.
- With Macro mode, you can take pictures as close as 40cm (16 in.). See "Macro" section.
- The lens retracts when the camera is turned off or Auto Power Off is activated. Touching the lens barrel while it is retracting may cause injury.

5. FILM REWIND

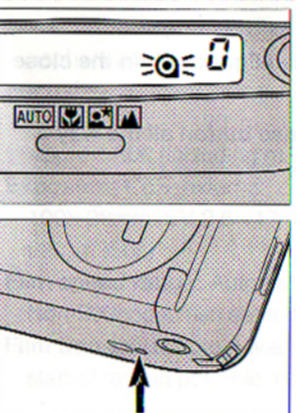

- The film will rewind automatically after the last frame has been exposed.
- When 0 appears and 0 blinks, open the back cover and remove the film.
- To begin rewind before the end of the roll, turn the camera on and gently press the rewind button using a pen or similar object.

CAUTION

- If rewind stops before the film has been completely rewound and all indicators blink, DO NOT OPEN THE BACK COVER, insert a fresh battery and press the rewind button.

6. USING THE BUILT-IN FLASH

When you turn on the camera, the built-in flash is set to autoflash mode (AUTO or AUTO) and will fire in low light.

	ISO 100	ISO 400
28mm	0.5-6.0m 20 in.-20 ft.	0.5-12m 20 in.-39 ft.
70mm	0.5-2.5m 20 in.-8 ft.	0.5-5m 20 in.-16 ft.

FLASH RANGE

The range of the built-in flash depends on the film speed and focal length you are using. To ensure proper exposure, make sure your subject is positioned within the flash range.

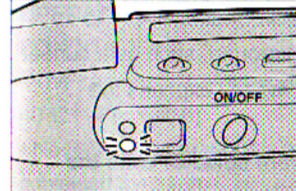

- FLASH LAMP**
- The orange flash lamp will glow whenever the built-in flash is on.
 - When the orange flash lamp blinks slowly, your scene is too dark for a sharp hand-held picture. Use flash or place the camera on a tripod.
 - When the orange flash lamp blinks rapidly, the flash is charging. Wait until it glows steadily and then take the picture.

FLASH MODE SELECTION

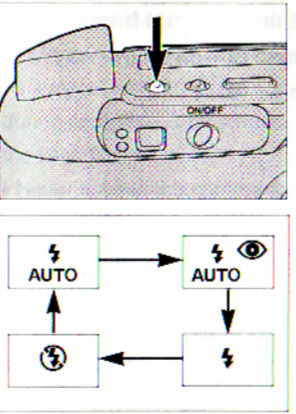

Besides autoflash mode (AUTO), autoflash with red-eye reduction (AUTO), manual fill-flash (F) or flash cancel (C) can be selected.

Press the flash-mode button until the desired indicator appears in the data panel.

RED-EYE REDUCTION (AUTO)

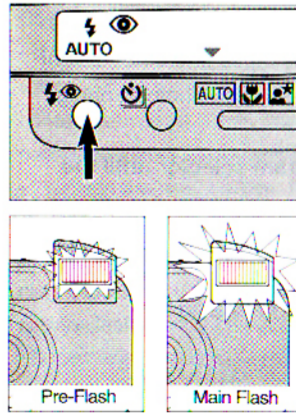

In this flash mode, the flash will fire a few short bursts before the main flash burst to reduce the "red-eye" effect which occurs when photographing people in low light.

Press the flash-mode button so that AUTO appears in the data panel and take the picture.

- Before taking the picture, warn the people you are photographing that the flash will fire a few short bursts before the picture is taken.
- The orange flash lamp will blink indicating pre-flash.

MANUAL FILL-FLASH (F)



The flash will fire with every shutter release regardless of lighting. This can be used to reduce harsh, unflattering shadows on your subject's face or illuminate your subject when it is back-lit.

Press the flash-mode button until F appears in the data panel and take the picture.

FLASH CANCEL (C)



The flash will not fire. This mode should be used when photographing twilight scenes or subjects that are beyond the flash range.

Press the flash-mode button until C appears in the data panel and take the picture.

- When the flash is canceled, shutter speeds may be slow; placing your camera on a tripod is highly recommended.

7. FOCUS LOCK



When your subject is located outside the focus frame, you can first lock focus on your subject and then recompose the picture as desired.

1. Align the subject within the focus frame and press the shutter-release button partway down until the green focus lamp glows.

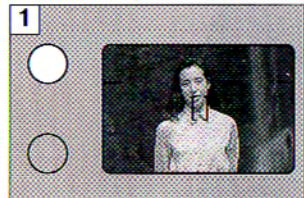



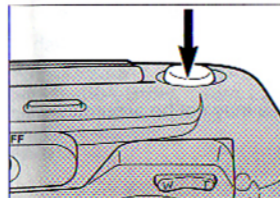

2. Without lifting your finger, recompose the picture and press the shutter-release button all the way down to take the picture.

• This camera incorporates the Multi-Beam AF system. When your subject is not in the focus frame, the side beams focus the camera on your subject, instead of the background. The position of the side beams is affected by focal length. For this reason, focus lock is recommended when your subject is not in the focus frame.

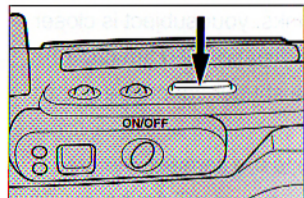

8. SUBJECT-PROGRAM SELECTION



Subject-Program Selection allows you to tailor the camera's fully automatic operation to suit the subject. It provides optimal camera settings for closeups (Macro ) , portraits at night (Night-Portrait ) , and distant subjects (Landscape ) .

Press the subject-program selector until the pointer is next to the desired indicator.

• After you take a picture in one of the subject-program modes, the camera will return to Full-Auto mode.

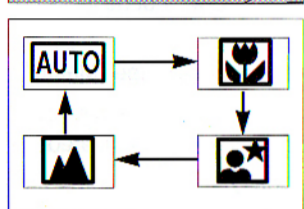

MACRO MODE



This mode enables you to take pictures of subjects as close as 40cm (16 in.).

1. Press the subject program selector until the pointer is next to 

• Approximately two seconds after you select Macro mode the lens will zoom to 70mm and lock.
• Autoflash mode is initially set, but any other flash mode can be selected.

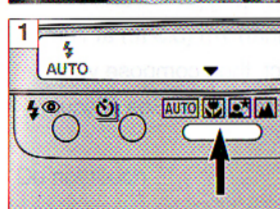

MACRO MODE CONT.

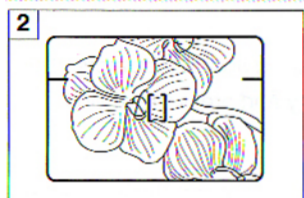

2. Align your subject within the focus frame and press the shutter-release button partway down until the green focus lamp glows.

• In Macro mode, your subject must be within 40cm (16 in.) and 1m (3.3 ft.) of the camera. The green focus lamp will blink if your subject is outside this range and the shutter cannot be released.
• If the subject is very close to the camera, the green focus lamp will glow, but the picture will not be in focus.

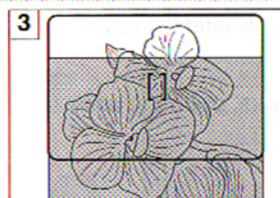

3. Without lifting your finger, recompose the picture so your subject is aligned within the close-framing guides.

4. Press the shutter-release button all the way down to take the picture.

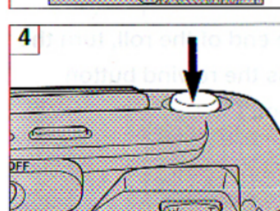

NIGHT-PORTRAIT MODE

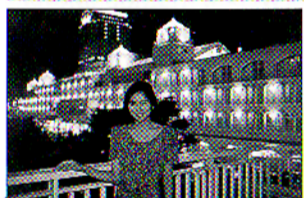

Night-portrait mode sets a slow-shutter speed to correctly expose a dark background, such as a sunset or night scene, while flash properly exposes the foreground.

1. Press the subject program selector until the pointer is next to 

• Shutter speeds may be too slow for sharp hand-held pictures; placing the camera on a tripod is highly recommended.
• Manual fill-flash is set and cannot be changed, but red-eye reduction can be selected.

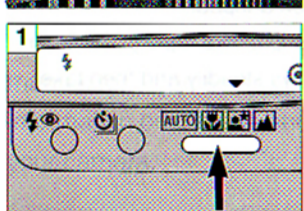

2. Align your subject within the focus frame and press the shutter-release button partway down.

3. When the orange flash lamp and green focus lamp glow, press the shutter-release button all the way down to take the picture.

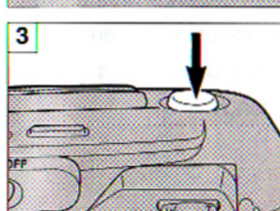

LANDSCAPE MODE



In this mode, focus is set to infinity. It can be used to ensure sharp focus for landscapes and other distant subjects, and should be used when photographing through glass.

1. Press the subject-program selector until the pointer is next to 

• At twilight or night, place your camera on a tripod to avoid blur caused by camera shake.
• Flash-cancel is set and cannot be changed.

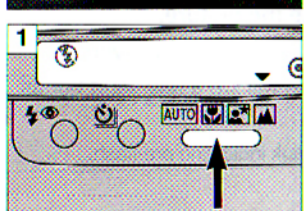

2. Align your subject within the focus frame.
3. Press the shutter-release button all the way down to take the picture.

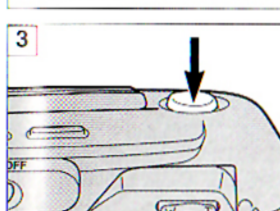

9. SELF-TIMER MODE

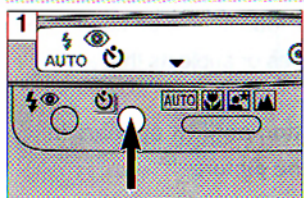

The electronic self-timer will delay release of the shutter for approximately 10 seconds after you press the shutter-release button. This enables you to take group photographs with yourself included.

1. Place the camera on a tripod and press the self-timer/drive-mode button until  appears in the data panel.

2. Align your subject within the focus frame.

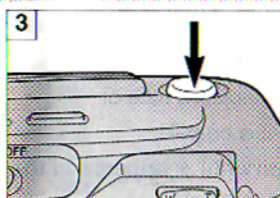

3. Press the shutter-release button all the way down.

• The self-timer indicator in the data panel and the self-timer lamp on the front of the camera will blink slowly during the self-timer countdown and blink rapidly just before the shutter release.
• To cancel self-timer operation, press the self-timer/drive-mode button or turn off the camera.
• Self-timer is automatically canceled after the shutter release.

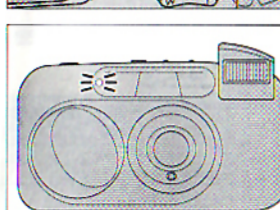

10. CONTINUOUS-DRIVE MODE



In this mode, the camera continuously takes pictures and advances the film as long as the shutter-release button is held down.

1. Press the self-timer/drive-mode button until  appears in the data panel.

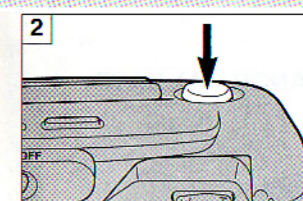
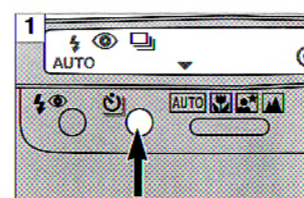

2. Press the shutter-release button down and hold.

• Without flash, the shutter will release every 1.2 seconds; with flash, the shutter will release when the flash is charged.
• Continuous-drive mode remains selected after you take the picture.
• The subject-program mode remains selected as long as you are pressing the shutter-release button. Full-Auto mode will be reset when you have finished a sequence.

11. FOR OWNERS OF THE DATE MODEL

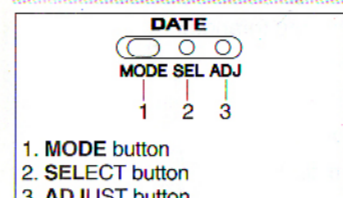

1. MODE button
2. SELECT button
3. ADJUST button

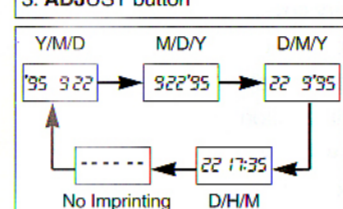

This feature enables you to record the date or time onto the lower-right portion of the picture. It has an automatic calendar through the year 2029.

Press the MODE button to choose the data imprinting format.

• Imprinted data may be difficult to read if the area over which it is superimposed is bright or non-uniform.
• Do not use the data back when temperatures exceed the operating range of 0° to 40°C (32° to 104°F).
• The data may not be imprinted on the last frame.

SETTING THE TIME AND DATE

1. Press the MODE button to select either Date or Time mode.
2. Use the SELECT button to move between different parts of the displayed data. The selected part will blink indicating that it is the data to be changed.
3. Press the ADJUST button to change the data to the correct value. Data continues changing as long as you hold down the button.
• In Time mode, pressing the ADJUST button while the colon is blinking reset the second counter to 00.
4. When all data is correct, press the SELECT button until the data stops blinking.

• Reset the time and date after changing the battery.

TECHNICAL DETAILS

Lens: 28-70mm f/3.5-8.4 power zoom lens with 4 elements in 4 groups including 2 aspherical surfaces
Focusing: 3-beam, active infrared autofocus system with focus lock; Focusing range: 0.5m - ∞ (20 in. - ∞), Macro: 0.4m - 1.0 (16 in. - 3.3 ft.); Focusing steps: Approx. 300 (including macro range)
Exposure: CdS; external, center-weighted average metering; Exposure range (ISO 100): 28mm: EV 2.6 - 17 (f/3.5, 2s - 1/16, 1/500s), 70mm: EV 3.1 - 17 (f/8.4, 8s - 1/20, 1/350s)
Film speed range: Automatic setting for DX-coded film ISO 25-3200 in 1EV steps; Non-DX-coded film set to ISO 25
Film transport: Auto advance to first frame, auto rewind, auto threading, manual start of rewind possible; continuous drive: 1.2 sec./frame (without flash)

Flash: Retractable, built-in flash, variable intensity through IGBT circuit; Recycling time: approx. 0.3 - 6 sec.; Range (ISO 100): 28mm: 0.5 - 6.0m (20 in. - 20 ft.), 70mm: 0.5 - 2.5m (20 in. - 8.2 ft.), Macro: 0.4 - 1.0m (16 in. - 3.3 ft.)
Viewfinder: Real-image; Field of view: Nominal 86% (subject at 3m/10 ft.) 28mm: 84% (V) x 87% (H), 70mm: 87% (V) x 85% (H); Diopter adjustment (subject at 3m/10 ft.): -1 diopter
Battery: One 3-volt CR123A/DL123A lithium battery
Battery performance: Approx. 13 rolls (24 exp. roll w/ 50% flash)
Dimensions: 121 x 66.5 x 44mm (4-3/4 x 2-5/8 x 1-3/4 in.)
Weight: 240g (8-1/2 oz.); Panorama model: 245g (8-5/8 oz.)
Specifications are based on the latest information available at the time of printing and are subject to change without notice.

CARING FOR YOUR CAMERA

BATTERY CAUTIONS

• Do not subject the battery to high temperatures or fire; do not attempt to disassemble, recharge or short-circuit it; the battery may explode causing severe burns.
• Read and follow all warnings and instructions supplied with the batteries.
• Keep batteries away from children.

• When photographing in cold weather, we recommend that you keep the camera and spare batteries inside your coat to keep them warm when you are not shooting. Cold batteries will regain some of their charge when they warm up.

OPERATING TEMPERATURE AND CONDITIONS

• This camera is designed for use for -10 to 40°C (14 to 104°F)
• Never leave your camera where it may be subjected to extreme temperatures such as the glove compartment of a car.
• At colder temperatures, the data panel response time will be slow; at higher temperatures, the display will temporarily darken and will restore when the temperature normalizes.

• Never subject your camera to extreme humidity.
• To prevent condensation from forming, place the camera in a sealed plastic bag when bringing it from the cold exterior to a warm building. Allow it to come to room temperature before removing it from the bag.

CARING FOR YOUR CAMERA CONT.

HANDLING CARE

• Do not touch or cover the flash tube and be sure to leave sufficient space around it during operation; it may become hot when the flash fires.
• Never subject the camera to shock, especially when transporting.
• This camera is not waterproof, dust-proof, or sand-proof; take care when using it at the beach or near water--costly or irreparable damage to the camera may occur.

• This camera contains high-voltage circuits; do not attempt to disassemble or repair it.
• If the camera does not operate with sufficient battery power or if all indicators in the data panel blink, remove and reinstall the battery. If the camera still does not operate, or this happens again, take it to an authorized Minolta Service facility.

CLEANING

• If the camera body is dirty, wipe it gently with a soft, clean, dry cloth. If it comes in contact with sand, gently blow away loose particles--wiping may scratch the surface.
• To clean the lens surface, first brush away any dust or sand with a lens brush and if necessary moisten a lens tissue with lens cleaning fluid and gently wipe the lens in a circular fashion from the center.
• Never use organic solvents to clean the camera.

• Never touch the lens surface with your fingers.

CARING FOR YOUR CAMERA CONT.

STORAGE

When storing your camera for extended periods, please follow these guidelines:
• Store in a cool, dry and well-ventilated area away from dust and chemicals such as moth balls. For very long periods, place the camera in an airtight container with silica gel drying agent.
• Periodically release the camera's shutter to keep it operating properly.

• Before using after prolonged storage always check the camera's operation to make sure that it is functioning properly.

QUESTIONS AND SERVICE

• If you have questions about your camera, contact your local camera dealer or write to the Minolta distributor in your area.
• Before shipping your camera for repair, please contact an authorized Minolta Service Facility for details.

This device complies with Part 15 of the FCC Rules. Operation is subject to the following two conditions: (1) This device may not cause harmful interference, and (2) this device must accept any interference received, including interference that may cause undesired operation. Changes or modifications not approved by the party responsible for compliance could void the user's authority to operate the equipment. This equipment has been tested and found to comply with the limits for a Class B digital device, pursuant to Part 15 of the FCC Rules. These limits are designed to provide reasonable protection against harmful interference in a residential installation. This equipment generates, uses and can radiate radio frequency energy and, if not installed and used in accordance with the instructions, may cause harmful interference to radio communications. However, there is no guarantee that interference will not occur in a particular installation. If this equipment does cause harmful interference to radio or television reception, which can be determined by turning the equipment off and on, the user is encouraged to try to correct the interference by one or more of the following measures:
• Reorient or relocate the receiving antenna.
• Increase the separation between the equipment and the receiver.
• Connect the equipment to an outlet on a circuit different from that to which the receiver is connected.
• Consult the dealer or an experienced radio/TV technician for help.

This Class B digital apparatus meets all requirements of the Canadian Interference-Causing Equipment Regulations.